

ETSI EN 300 328 V2.1.1 (2016-11)



HARMONISED EUROPEAN STANDARD

**Wideband transmission systems;
Data transmission equipment operating
in the 2,4 GHz ISM band and
using wide band modulation techniques;
Harmonised Standard covering the essential requirements
of article 3.2 of Directive 2014/53/EU**

Reference

REN/ERM-TG11-011

Keywords

broadband, data, harmonised standard, ISM,
LAN, mobile, radio, regulation, spread spectrum,
SRD, testing, transmission, UHF

ETSI

650 Route des Lucioles
F-06921 Sophia Antipolis Cedex - FRANCE

Tel.: +33 4 92 94 42 00 Fax: +33 4 93 65 47 16

Siret N° 348 623 562 00017 - NAF 742 C
Association à but non lucratif enregistrée à la
Sous-Préfecture de Grasse (06) N° 7803/88

Important notice

The present document can be downloaded from:
<http://www.etsi.org/standards-search>

The present document may be made available in electronic versions and/or in print. The content of any electronic and/or print versions of the present document shall not be modified without the prior written authorization of ETSI. In case of any existing or perceived difference in contents between such versions and/or in print, the only prevailing document is the print of the Portable Document Format (PDF) version kept on a specific network drive within ETSI Secretariat.

Users of the present document should be aware that the document may be subject to revision or change of status. Information on the current status of this and other ETSI documents is available at
<https://portal.etsi.org/TB/ETSIDeliverableStatus.aspx>

If you find errors in the present document, please send your comment to one of the following services:
<https://portal.etsi.org/People/CommiteeSupportStaff.aspx>

Copyright Notification

No part may be reproduced or utilized in any form or by any means, electronic or mechanical, including photocopying and microfilm except as authorized by written permission of ETSI.

The content of the PDF version shall not be modified without the written authorization of ETSI.
The copyright and the foregoing restriction extend to reproduction in all media.

© European Telecommunications Standards Institute 2016.
All rights reserved.

DECT™, **PLUGTESTS™**, **UMTS™** and the ETSI logo are Trade Marks of ETSI registered for the benefit of its Members.
3GPP™ and **LTE™** are Trade Marks of ETSI registered for the benefit of its Members and of the 3GPP Organizational Partners.
GSM® and the GSM logo are Trade Marks registered and owned by the GSM Association.

Contents

Intellectual Property Rights	9
Foreword.....	9
Modal verbs terminology.....	9
Introduction	9
1 Scope	10
2 References	10
2.1 Normative references	10
2.2 Informative references.....	10
3 Definitions, symbols and abbreviations	11
3.1 Definitions	11
3.2 Symbols.....	13
3.3 Abbreviations	14
4 Technical requirements specifications	15
4.1 Environmental profile.....	15
4.2 Equipment types	15
4.2.1 Modulation types	15
4.2.2 Adaptive and non-adaptive equipment	15
4.2.3 Receiver categories	15
4.2.3.1 Introduction	15
4.2.3.2 Categorization	15
4.2.3.2.1 Receiver category 1	15
4.2.3.2.2 Receiver category 2	16
4.2.3.2.3 Receiver category 3	16
4.3 Conformance requirements	16
4.3.1 Requirements for Frequency Hopping equipment	16
4.3.1.1 Introduction.....	16
4.3.1.2 RF output power.....	16
4.3.1.2.1 Applicability	16
4.3.1.2.2 Definition.....	16
4.3.1.2.3 Limit	16
4.3.1.2.4 Conformance	16
4.3.1.3 Duty Cycle, Tx-sequence, Tx-gap.....	16
4.3.1.3.1 Applicability	16
4.3.1.3.2 Definition.....	17
4.3.1.3.3 Limit	17
4.3.1.3.4 Conformance	17
4.3.1.4 Accumulated Transmit Time, Frequency Occupation and Hopping Sequence.....	17
4.3.1.4.1 Applicability	17
4.3.1.4.2 Definition.....	17
4.3.1.4.3 Limit	17
4.3.1.4.4 Other Requirements.....	18
4.3.1.4.5 Conformance	18
4.3.1.5 Hopping Frequency Separation.....	19
4.3.1.5.1 Applicability	19
4.3.1.5.2 Definition.....	19
4.3.1.5.3 Limit	19
4.3.1.5.4 Conformance	19
4.3.1.6 Medium Utilization (MU) factor.....	19
4.3.1.6.1 Applicability	19
4.3.1.6.2 Definition.....	20
4.3.1.6.3 Limit	20
4.3.1.6.4 Conformance	20
4.3.1.7 Adaptivity (Adaptive Frequency Hopping).....	20
4.3.1.7.1 Applicability	20

4.3.1.7.2	Adaptive Frequency Hopping using LBT based DAA	20
4.3.1.7.3	Adaptive Frequency Hopping using other forms of DAA (non-LBT based)	22
4.3.1.7.4	Short Control Signalling Transmissions	23
4.3.1.8	Occupied Channel Bandwidth.....	23
4.3.1.8.1	Applicability	23
4.3.1.8.2	Definition.....	24
4.3.1.8.3	Limits	24
4.3.1.8.4	Conformance	24
4.3.1.9	Transmitter unwanted emissions in the out-of-band domain	24
4.3.1.9.1	Applicability	24
4.3.1.9.2	Definition.....	24
4.3.1.9.3	Limit	24
4.3.1.9.4	Conformance	24
4.3.1.10	Transmitter unwanted emissions in the spurious domain.....	25
4.3.1.10.1	Applicability	25
4.3.1.10.2	Definition.....	25
4.3.1.10.3	Limit	25
4.3.1.10.4	Conformance	25
4.3.1.11	Receiver spurious emissions	25
4.3.1.11.1	Applicability	25
4.3.1.11.2	Definition.....	25
4.3.1.11.3	Limit	25
4.3.1.11.4	Conformance	26
4.3.1.12	Receiver Blocking.....	26
4.3.1.12.1	Applicability	26
4.3.1.12.2	Definition.....	26
4.3.1.12.3	Performance Criteria	26
4.3.1.12.4	Limits	26
4.3.1.12.5	Conformance	27
4.3.1.13	Geo-location capability	27
4.3.1.13.1	Applicability	27
4.3.1.13.2	Definition.....	27
4.3.1.13.3	Requirements	28
4.3.2	Requirements for other types of Wide Band modulation.....	28
4.3.2.1	Introduction.....	28
4.3.2.2	RF output power.....	28
4.3.2.2.1	Applicability	28
4.3.2.2.2	Definition.....	28
4.3.2.2.3	Limit	28
4.3.2.2.4	Conformance	28
4.3.2.3	Power Spectral Density	28
4.3.2.3.1	Applicability	28
4.3.2.3.2	Definition.....	28
4.3.2.3.3	Limit	29
4.3.2.3.4	Conformance	29
4.3.2.4	Duty Cycle, Tx-sequence, Tx-gap.....	29
4.3.2.4.1	Applicability	29
4.3.2.4.2	Definition.....	29
4.3.2.4.3	Limit	29
4.3.2.4.4	Conformance	29
4.3.2.5	Medium Utilization (MU) factor.....	29
4.3.2.5.1	Applicability	29
4.3.2.5.2	Definition.....	29
4.3.2.5.3	Limit	30
4.3.2.5.4	Conformance	30
4.3.2.6	Adaptivity (adaptive equipment using modulations other than FHSS).....	30
4.3.2.6.1	Applicability	30
4.3.2.6.2	Non-LBT based Detect and Avoid	30
4.3.2.6.3	LBT based Detect and Avoid	31
4.3.2.6.4	Short Control Signalling Transmissions.....	34
4.3.2.7	Occupied Channel Bandwidth.....	34
4.3.2.7.1	Applicability	34

4.3.2.7.2	Definition.....	35
4.3.2.7.3	Limits	35
4.3.2.7.4	Conformance	35
4.3.2.8	Transmitter unwanted emissions in the out-of-band domain	35
4.3.2.8.1	Applicability	35
4.3.2.8.2	Definition.....	35
4.3.2.8.3	Limit	35
4.3.2.8.4	Conformance	35
4.3.2.9	Transmitter unwanted emissions in the spurious domain.....	36
4.3.2.9.1	Applicability	36
4.3.2.9.2	Definition.....	36
4.3.2.9.3	Limit	36
4.3.2.9.4	Conformance	36
4.3.2.10	Receiver spurious emissions	36
4.3.2.10.1	Applicability	36
4.3.2.10.2	Definition.....	36
4.3.2.10.3	Limit	36
4.3.2.10.4	Conformance	37
4.3.2.11	Receiver Blocking.....	37
4.3.2.11.1	Applicability	37
4.3.2.11.2	Definition.....	37
4.3.2.11.3	Performance Criteria	37
4.3.2.11.4	Limits	37
4.3.2.11.5	Conformance	38
4.3.2.12	Geo-location capability	38
4.3.2.12.1	Applicability	38
4.3.2.12.2	Definition.....	38
4.3.2.12.3	Requirements.....	39
5	Testing for compliance with technical requirements.....	39
5.1	Environmental conditions for testing	39
5.1.1	Introduction.....	39
5.1.2	Normal test conditions	39
5.1.2.1	Normal temperature and humidity	39
5.1.2.2	Normal power source	39
5.1.3	Extreme test conditions.....	39
5.2	Interpretation of the measurement results	39
5.3	Definition of other test conditions	40
5.3.1	Test mode.....	40
5.3.2	Antennas and transmit operating modes	40
5.3.2.1	Integrated and dedicated antennas.....	40
5.3.2.2	Smart antenna systems and related operating modes	41
5.3.2.2.1	Introduction	41
5.3.2.2.2	Operating mode 1 (single antenna).....	41
5.3.2.2.3	Operating mode 2 (multiple antennas, no beamforming)	41
5.3.2.2.4	Operating mode 3 (multiple antennas, with beamforming)	41
5.3.2.3	Configuration for testing	41
5.3.3	Adaptive and Non-adaptive equipment.....	41
5.3.4	Presentation of equipment	41
5.3.4.1	Introduction.....	41
5.3.4.2	Testing of stand-alone equipment	41
5.3.4.3	Testing of host connected equipment and plug-in radio equipment.....	42
5.3.4.3.1	Introduction	42
5.3.4.3.2	The use of a host or test jig for testing plug-in radio equipment	42
5.3.4.3.3	Testing of combinations	42
5.3.5	Conducted measurements, radiated measurements, relative measurements	43
5.4	Test procedures for essential radio test suites.....	43
5.4.1	Product Information.....	43
5.4.2	RF output power, Duty Cycle, Tx-sequence, Tx-gap, Medium Utilization	44
5.4.2.1	Test conditions	44
5.4.2.2	Test method.....	45
5.4.2.2.1	Conducted measurements	45

5.4.2.2.2	Radiated measurements	47
5.4.3	Power Spectral Density	47
5.4.3.1	Test conditions	47
5.4.3.2	Test method	48
5.4.3.2.1	Conducted measurement	48
5.4.3.2.2	Radiated measurement	50
5.4.4	Accumulated Transmit Time, Frequency Occupation and Hopping Sequence	50
5.4.4.1	Test conditions	50
5.4.4.2	Test method	50
5.4.4.2.1	Conducted measurements	50
5.4.4.2.2	Radiated measurements	52
5.4.5	Hopping Frequency Separation	52
5.4.5.1	Test conditions	52
5.4.5.2	Test method	52
5.4.5.2.1	Conducted measurements	52
5.4.5.2.2	Radiated measurements	55
5.4.6	Adaptivity (Channel access mechanism)	55
5.4.6.1	Test conditions	55
5.4.6.2	Test Method	55
5.4.6.2.1	Conducted measurements	55
5.4.6.2.2	Radiated measurements	63
5.4.7	Occupied Channel Bandwidth	64
5.4.7.1	Test conditions	64
5.4.7.2	Test method	64
5.4.7.2.1	Conducted measurement	64
5.4.7.2.2	Radiated measurement	64
5.4.8	Transmitter unwanted emissions in the out-of-band domain	65
5.4.8.1	Test conditions	65
5.4.8.2	Test method	65
5.4.8.2.1	Conducted measurement	65
5.4.8.2.2	Radiated measurement	66
5.4.9	Transmitter unwanted emissions in the spurious domain	67
5.4.9.1	Test conditions	67
5.4.9.2	Test method	67
5.4.9.2.1	Conducted measurement	67
5.4.9.2.2	Radiated measurement	69
5.4.10	Receiver spurious emissions	70
5.4.10.1	Test conditions	70
5.4.10.2	Test method	70
5.4.10.2.1	Conducted measurement	70
5.4.10.2.2	Radiated measurement	72
5.4.11	Receiver Blocking	72
5.4.11.1	Test conditions	72
5.4.11.2	Test Method	72
5.4.11.2.1	Conducted measurements	72
5.4.11.2.2	Radiated measurements	74

Annex A (informative):	Relationship between the present document and the essential requirements of Directive 2014/53/EU	75
-------------------------------	---	-----------

Annex B (normative):	Test sites and arrangements for radiated measurement	77
-----------------------------	---	-----------

B.1	Introduction	77
B.2	Radiation test sites	77
B.2.1	Open Area Test Site (OATS)	77
B.2.2	Semi Anechoic Room	78
B.2.3	Fully Anechoic Room (FAR)	79
B.2.4	Measurement Distance	80
B.3	Antennas	81
B.3.1	Introduction	81
B.3.2	Measurement antenna	81

B.3.3	Substitution antenna	81
B.4	Test fixture	81
B.4.1	Conducted measurements and use of test fixture	81
B.4.2	Description of the test fixture	82
B.4.3	Using the test fixture for relative measurements	82
B.5	Guidance on the use of radiation test sites	82
B.5.1	Introduction	82
B.5.2	Power supplies for a battery-only powered UUT	82
B.5.3	Site preparation	83
B.6	Coupling of signals.....	83
B.7	Interference Signal used for Adaptivity Tests	83
Annex C (normative): Measurement procedures for radiated measurement		85
C.1	Introduction	85
C.2	Radiated measurements in an OATS or SAR.....	85
C.3	Radiated measurements in a FAR	85
C.4	Substitution measurement	86
C.5	Guidance for testing technical requirements	86
C.5.1	Introduction	86
C.5.2	Test procedures and corresponding test sites	86
C.5.3	Guidance for testing Adaptivity (Channel Access Mechanism).....	87
C.5.3.1	Introduction.....	87
C.5.3.2	Measurement Set-up	87
C.5.3.3	Calibration of the measurement Set-up.....	87
C.5.3.4	Test method	88
C.5.4	Guidance for testing Receiver Blocking.....	88
C.5.4.1	Introduction.....	88
C.5.4.2	Measurement Set-up	88
C.5.4.3	Calibration of the measurement Set-up.....	88
C.5.4.4	Test method	89
Annex D (informative): Guidance for testing 2,4 GHz IEEE 802.11™ Equipment		90
D.1	Introduction	90
D.2	Possible Modulations	90
D.2.1	Introduction	90
D.2.2	Guidance for Testing	90
D.2.2.1	Introduction.....	90
D.2.2.2	Modulation Used for Conformance Testing	90
D.3	Possible Operating Modes.....	91
D.3.1	Introduction	91
D.3.2	Guidance for Testing.....	91
Annex E (informative): Application form for testing.....		93
E.1	Introduction	93
E.2	Information as required by ETSI EN 300 328 V2.1.1, clause 5.4.1.....	93
E.3	Configuration for testing (see clause 5.3.2.3 of ETSI EN 300 328 V2.1.1).....	98
E.4	Additional information provided by the manufacturer.....	98
E.4.1	Modulation	98
E.4.2	Duty Cycle.....	99
E.4.3	About the UUT	99
E.4.4	Additional items and/or supporting equipment provided	99

Annex F (informative):	Change History	100
History		101

Intellectual Property Rights

IPRs essential or potentially essential to the present document may have been declared to ETSI. The information pertaining to these essential IPRs, if any, is publicly available for **ETSI members and non-members**, and can be found in ETSI SR 000 314: "*Intellectual Property Rights (IPRs); Essential, or potentially Essential, IPRs notified to ETSI in respect of ETSI standards*", which is available from the ETSI Secretariat. Latest updates are available on the ETSI Web server (<https://ipr.etsi.org/>).

Pursuant to the ETSI IPR Policy, no investigation, including IPR searches, has been carried out by ETSI. No guarantee can be given as to the existence of other IPRs not referenced in ETSI SR 000 314 (or the updates on the ETSI Web server) which are, or may be, or may become, essential to the present document.

Foreword

This Harmonised European Standard (EN) has been produced by ETSI Technical Committee Electromagnetic compatibility and Radio spectrum Matters (ERM).

The present document has been prepared under the Commission's standardisation request C(2015) 5376 final [i.14] to provide one voluntary means of conforming to the essential requirements of Directive 2014/53/EU on the harmonisation of the laws of the Member States relating to the making available on the market of radio equipment and repealing Directive 1999/5/EC [i.1].

Once the present document is cited in the Official Journal of the European Union under that Directive, compliance with the normative clauses of the present document given in table A.1 confers, within the limits of the scope of the present document, a presumption of conformity with the corresponding essential requirements of that Directive, and associated EFTA regulations.

National transposition dates	
Date of adoption of this EN:	14 November 2016
Date of latest announcement of this EN (doa):	28 February 2017
Date of latest publication of new National Standard or endorsement of this EN (dop/e):	31 August 2017
Date of withdrawal of any conflicting National Standard (dow):	31 August 2018

Modal verbs terminology

In the present document "**shall**", "**shall not**", "**should**", "**should not**", "**may**", "**need not**", "**will**", "**will not**", "**can**" and "**cannot**" are to be interpreted as described in clause 3.2 of the [ETSI Drafting Rules](#) (Verbal forms for the expression of provisions).

"**must**" and "**must not**" are **NOT** allowed in ETSI deliverables except when used in direct citation.

Introduction

The present document covers Wide Band Data Transmission equipment.

Examples of Wide Band Data Transmission equipment are equipments such as IEEE 802.11™ RLANs [i.3], Bluetooth® wireless technologies, Zigbee™, etc.

1 Scope

The present document applies to Wide Band Data Transmission equipment.

The present document also describes spectrum access requirements to facilitate spectrum sharing with other equipment.

Wide Band Data Transmission equipment covered by the present document is operated in accordance with the ERC Recommendation 70-03 [i.6], annex 3 or Commission Decision 2006/771/EC [i.7] (and its amendments).

This radio equipment is capable of operating in the band provided in table 1.

Table 1: Service frequency bands

	Service frequency bands
Transmit	2 400 MHz to 2 483,5 MHz
Receive	2 400 MHz to 2 483,5 MHz

Equipment using Ultra Wide Band (UWB) technology is not covered by the present document.

The present document contains requirements to demonstrate that radio equipment both effectively uses and supports the efficient use of radio spectrum in order to avoid harmful interference.

2 References

2.1 Normative references

References are either specific (identified by date of publication and/or edition number or version number) or non-specific. For specific references, only the cited version applies. For non-specific references, the latest version of the referenced document (including any amendments) applies.

Referenced documents which are not found to be publicly available in the expected location might be found at <http://docbox.etsi.org/Reference>.

NOTE: While any hyperlinks included in this clause were valid at the time of publication, ETSI cannot guarantee their long term validity.

The following referenced documents are necessary for the application of the present document.

Not applicable.

2.2 Informative references

References are either specific (identified by date of publication and/or edition number or version number) or non-specific. For specific references, only the cited version applies. For non-specific references, the latest version of the referenced document (including any amendments) applies.

NOTE: While any hyperlinks included in this clause were valid at the time of publication, ETSI cannot guarantee their long term validity.

The following referenced documents are not necessary for the application of the present document but they assist the user with regard to a particular subject area.

[i.1] Directive 2014/53/EU of the European Parliament and of the Council of 16 April 2014 on the harmonisation of the laws of the Member States relating to the making available on the market of radio equipment and repealing Directive 1999/5/EC.

[i.2] Void.

- [i.3] IEEE Std. 802.11™-2012: "IEEE Standard for Information Technology - Telecommunications and information exchange between systems - Local and metropolitan area networks - Specific requirements. Part 11: Wireless LAN Medium Access Control (MAC) and Physical Layer (PHY) Specifications".
- [i.4] IEEE Std. 802.15.4™-2011: "IEEE Standard for Information technology - Telecommunications and information exchange between systems - Local and metropolitan area networks - Specific requirements. Part 15.4: Wireless Medium Access Control (MAC) and Physical Layer (PHY) Specifications for Low-Rate Wireless Personal Area Networks (WPANs)".
- [i.5] Void.
- [i.6] CEPT ERC Recommendation 70-03 (1997): "Relating to the use of Short Range Devices (SRD)".
- [i.7] Commission Decision 2006/771/EC of 9 November 2006 on harmonisation of the radio spectrum for use by short-range devices.
- [i.8] ETSI TR 102 273-2 (V1.2.1): "Electromagnetic compatibility and Radio spectrum Matters (ERM); Improvement on Radiated Methods of Measurement (using test site) and evaluation of the corresponding measurement uncertainties; Part 2: Anechoic chamber".
- [i.9] ETSI TR 102 273-3 (V1.2.1): "Electromagnetic compatibility and Radio spectrum Matters (ERM); Improvement on Radiated Methods of Measurement (using test site) and evaluation of the corresponding measurement uncertainties; Part 3: Anechoic chamber with a ground plane".
- [i.10] ETSI TR 102 273-4 (V1.2.1): "Electromagnetic compatibility and Radio spectrum Matters (ERM); Improvement on Radiated Methods of Measurement (using test site) and evaluation of the corresponding measurement uncertainties; Part 4: Open area test site".
- [i.11] ETSI TR 100 028-2 (V1.4.1): "Electromagnetic compatibility and Radio spectrum Matters (ERM); Uncertainties in the measurement of mobile radio equipment characteristics; Part 2".
- [i.12] Void.
- [i.13] Void.
- [i.14] Commission Implementing Decision C(2015) 5376 final of 4.8.2015 on a standardisation request to the European Committee for Electrotechnical Standardisation and to the European Telecommunications Standards Institute as regards radio equipment in support of Directive 2014/53/EU of the European Parliament and of the Council.
- [i.15] ETSI TR 100 028-1 (V1.4.1) (12-2001): "Electromagnetic compatibility and Radio spectrum Matters (ERM); Uncertainties in the measurement of mobile radio equipment characteristics; Part 1".

3 Definitions, symbols and abbreviations

3.1 Definitions

For the purposes of the present document, the terms and definitions given in Directive 2014/53/EU [i.1] and the following apply:

adaptive equipment: equipment operating in an adaptive mode

adaptive frequency hopping: mechanism that allows a frequency hopping equipment to adapt to its radio environment by identifying channels that are being used and excluding them from the list of available channels

adaptive mode: mode in which equipment can adapt its medium access to its radio environment by identifying other transmissions present in the band

adjacent channel: channels on either side of the nominal channel separated by the nominal channel bandwidth

adjacent hopping frequency: neighbouring hopping frequency which is separated by the minimum hopping frequency separation

antenna assembly: combination of the antenna (integral or dedicated), its feeder (e.g. coaxial cable) and if applicable, its antenna connector and associated switching components

NOTE: The gain of an antenna assembly (G) in dBi, does not include the additional gain that may result out of beamforming. This term (antenna assembly) refers to an antenna connected to one transmit chain.

beamforming gain: additional (antenna) gain realized by using beamforming techniques in smart antenna systems

NOTE: Beamforming gain as used in the present document, does not include the gain of the antenna assembly.

blacklisted frequency: hopping frequency occupied by frequency hopping equipment without having transmissions during the dwell time

clear channel assessment: mechanism used by an equipment to identify other transmissions in the channel

combined equipment: any combination of non-radio equipment that requires a plug-in radio equipment to offer full functionality

dedicated antenna: removable antenna(s) assessed together with the radio equipment against the requirements of the present document

detect and avoid: mechanism which mitigates interference potential by avoiding use of frequencies upon detection of other transmissions on those frequencies

direct sequence spread spectrum: form of modulation where a combination of data to be transmitted and a known code sequence (chip sequence) is used to directly modulate a carrier

NOTE: The transmitted bandwidth is determined by the chip rate and the modulation scheme.

dwell time: time between frequency changes for Frequency Hopping equipment

NOTE: The Dwell Time might comprise transmit, receive and idle phases of the equipment.

energy detect: mechanism used by an LBT based adaptive equipment to determine the presence of other devices operating on the channel based on detecting the signal level of that other device

environmental profile: range of environmental conditions for the equipment

frame based equipment: equipment where the transmit/receive structure is not directly demand-driven but has fixed timing

frequency hopping spread spectrum: spread spectrum technique in which the equipment occupies a number of frequencies in time, each for some period of time, referred to as the dwell time

NOTE: Transmitter and receiver follow the same frequency hop pattern. The frequency range is determined by the lowest and highest hop positions and the bandwidth per hop position.

geo-location capability: capability of equipment to determine its geographical location

hopping frequency: any of the (centre) frequencies defined within the hopping sequence of an FHSS equipment

host equipment: any equipment which has complete user functionality when not connected to the radio equipment part and to which the radio equipment part provides additional functionality and to which connection is necessary for the radio equipment part to offer functionality

idle period: period in time following a transmission sequence during which the equipment does not transmit

integral antenna: antenna designed as a fixed part of the equipment, without the use of an external connector and which cannot be disconnected from the equipment by a user with the intent to connect another antenna

NOTE: An integral antenna may be fitted internally or externally. In the case where the antenna is external, a non-detachable cable may be used. An antenna using internal connectors to connect to the internal radio part (e.g. printed circuit board) is considered to be an integral antenna.

Listen Before Talk (LBT): mechanism by which an equipment first applies CCA before using the channel

load based equipment: equipment where the transmit/receive structure is demand-driven

multi-radio equipment: radio, host or combined equipment using more than one radio transceiver

necessary bandwidth: width of the frequency band which is just sufficient to ensure the transmission of information at the rate and with the quality required under specified conditions

nominal channel bandwidth: band of frequencies assigned to a single channel

NOTE: The Nominal Channel Bandwidth is declared by the manufacturer as outlined in clause 5.4.1.

operating frequency: nominal frequency at which the equipment can be operated

NOTE: Equipment may be adjustable for operation at more than one operating frequency.

out-of-band emission: emission on a frequency or frequencies immediately outside the necessary bandwidth which results from the modulation process, but excluding emissions in the spurious domain

plug-in radio equipment: radio equipment module intended to be used with or within host, combined or multi-radio equipment, using their control functions and power supply

power envelope: RF power versus frequency contour

power spectral density: mean power in a given reference bandwidth

receive chain: receiver circuit with an associated antenna assembly

NOTE: Two or more receive chains are combined in a smart antenna assembly.

smart antenna systems: equipment that combines multiple transmit and/or receive chains with a signal processing function to increase the throughput and/or to optimize its radiation and/or reception capabilities

NOTE: These are techniques such as spatial multiplexing, beamforming, cyclic delay diversity, MIMO, etc.

spurious emissions: emissions on a frequency or frequencies which are outside the necessary bandwidth and the level of which may be reduced without affecting the corresponding transmission of information

NOTE: Spurious emissions include harmonic emissions, parasitic emissions, intermodulation products and frequency conversion products, but exclude out-of-band emissions.

stand-alone radio equipment: equipment that is intended primarily as communications equipment and that is normally used on a stand-alone basis

transmission burst: period in time during a transmission during which the transmitter is continuously on

transmit chain: transmitter circuit with an associated antenna assembly

NOTE: Two or more transmit chains are combined in a smart antenna system.

ultra wide band technology: technology for short-range radiocommunication, involving the intentional generation and transmission of radio-frequency energy that spreads over a very large frequency range, which may overlap several frequency bands allocated to radiocommunication services

wide band modulation: modulation such as FHSS, DSSS, OFDM, etc.

3.2 Symbols

For the purposes of the present document, the following symbols apply:

A_{ch}	number of active transmit chains
BW_{CHAN}	Channel Bandwidth
dBm	dB relative to 1 milliwatt
dBp	dB relative to peak power

dBW	dB relative to 1 Watt
F _{HS}	Hopping Frequency Separation
GHz	GigaHertz
Hz	Hertz
kHz	kiloHertz
MHz	MegaHertz
mW	milliWatt
ms	millisecond
MS/s	Mega Samples per second
N	Number of hopping frequencies
P _{out}	Output Power
TxOff	Transmitter Off
TxOn	Transmitter On

3.3 Abbreviations

For the purposes of the present document, the following abbreviations apply:

AC	Alternating Current
AC/DC	Alternating Current/Direct Current
ACK	ACKnowledgement
AFH	Adaptive Frequency Hopping
BW	BandWidth
CCA	Clear Channel Assessment
CE	Conformité Européenne
CSD	Cyclic Shift Diversity
CW	Continuous Wave
DAA	Detect And Avoid
DC	Duty Cycle
DSSS	Direct Sequence Spread Spectrum
e.i.r.p.	equivalent isotropically radiated power
e.r.p.	effective radiated power
EMC	ElectroMagnetic Compatibility
FAR	Fully Anechoic Room
FFT	Fast Fourier Transformation
FHSS	Frequency Hopping Spread Spectrum
HT	High Throughput
ISM	Industrial, Scientific and Medical
LBT	Listen Before Talk
LPDA	Logarithmic Periodic Dipole Antenna
MCS	Modulation and Coding Scheme
MS/s	Mega-Samples per second
MU	Medium Utilization
NACK	Not ACKnowledged
OATS	Open Air Test Site
OFDM	Orthogonal Frequency Division Multiplexing
OOB	Out Of Band
PSD	Power Spectral Density
PER	Packet Error Rate
RBW	Resolution BandWidth
RF	Radio Frequency
RMS	Root Mean Square
SAR	Semi Anechoic Room
TL	Threshold Level
Tx	Transmitter
UUT	Unit Under Test
VBW	Video BandWidth

4 Technical requirements specifications

4.1 Environmental profile

The technical requirements of the present document apply under the environmental profile for operation of the equipment, which shall be declared by the manufacturer. The equipment shall comply with all the technical requirements of the present document at all times when operating within the boundary limits of the declared operational environmental profile.

4.2 Equipment types

4.2.1 Modulation types

The present document defines two categories of Wide Band Data Transmission equipment:

- Equipment using Frequency Hopping Spread Spectrum (FHSS) modulation.
- Equipment using other types of wide band modulation (e.g. DSSS, OFDM, etc.).

The manufacturer can categorize the equipment to any of the above as long as the equipment complies with the corresponding requirements defined in either clause 4.3.1 or clause 4.3.2. This is part of the product information to be declared by the manufacturer. See clause 5.4.1.

4.2.2 Adaptive and non-adaptive equipment

The present document covers both adaptive and non-adaptive equipment.

Adaptive equipment uses an automatic mechanism which allows the equipment to adapt automatically to its radio environment by identifying frequencies that are being used by other equipment.

Non-adaptive equipment does not use such an automatic mechanism and hence are subject to certain restrictions with respect to using the medium (see clause 4.3.1.6 and clause 4.3.2.5 for Medium Utilization factor) in order to ensure sharing with other equipment.

Adaptive equipment may have more than one adaptive mode implemented.

Adaptive equipment is allowed to operate in a non-adaptive mode.

The equipment shall comply with the corresponding requirements in each of the modes in which it can operate.

The manufacturer shall declare whether the equipment is adaptive equipment or non-adaptive equipment. In case of adaptive equipment, the manufacturer shall declare if more than one adaptive mode is implemented and whether the equipment can also operate in a non-adaptive mode. See also clause 5.4.1.

4.2.3 Receiver categories

4.2.3.1 Introduction

The present document covers different receiver categories for which different receiver requirements and/or corresponding limits apply.

4.2.3.2 Categorization

4.2.3.2.1 Receiver category 1

Adaptive equipment with a maximum RF output power greater than 10 dBm e.i.r.p. shall be considered as receiver category 1 equipment.

4.2.3.2.2 Receiver category 2

Non-adaptive equipment with a Medium Utilization (MU) factor greater than 1 % and less than or equal to 10 % or adaptive equipment with a maximum RF output power of 10 dBm e.i.r.p. shall be considered as receiver category 2 equipment.

4.2.3.2.3 Receiver category 3

Non-adaptive equipment with a maximum Medium Utilization (MU) factor of 1 % or adaptive equipment with a maximum RF output power of 0 dBm e.i.r.p. shall be considered as receiver category 3 equipment.

4.3 Conformance requirements

4.3.1 Requirements for Frequency Hopping equipment

4.3.1.1 Introduction

Equipment using FHSS modulation, and further referred to as Frequency Hopping equipment, shall comply with the requirements in clause 4.3.1.2 to clause 4.3.1.13.

For equipment using other forms of modulation, the requirements in clause 4.3.2 shall apply.

4.3.1.2 RF output power

4.3.1.2.1 Applicability

This requirement applies to all types of Frequency Hopping equipment.

4.3.1.2.2 Definition

The RF output power is defined as the mean equivalent isotropically radiated power (e.i.r.p.) of the equipment during a transmission burst.

4.3.1.2.3 Limit

The maximum RF output power for adaptive Frequency Hopping equipment shall be equal to or less than 20 dBm.

The maximum RF output power for non-adaptive Frequency Hopping equipment shall be declared by the manufacturer. See clause 5.4.1 m). The maximum RF output power for this equipment shall be equal to or less than the value declared by the manufacturer. This declared value shall be equal to or less than 20 dBm.

This limit shall apply for any combination of power level and intended antenna assembly.

4.3.1.2.4 Conformance

The conformance tests for this requirement are defined in clause 5.4.2 and specifically in clause 5.4.2.2.1.2.

4.3.1.3 Duty Cycle, Tx-sequence, Tx-gap

4.3.1.3.1 Applicability

These requirements apply to non-adaptive frequency hopping equipment or to adaptive frequency hopping equipment operating in a non-adaptive mode.

These requirements do not apply for equipment with a maximum declared RF Output power of less than 10 dBm e.i.r.p. or for equipment when operating in a mode where the RF Output power is less than 10 dBm e.i.r.p.

4.3.1.3.2 Definition

Duty Cycle is defined as the ratio of the total transmitter 'on'-time to an observation period.

The observation period is equal to:

- the average dwell time multiplied by 100;
- or
- the average dwell time multiplied by 2 times the number of hopping frequencies (N);

whichever is the greater.

Tx-sequence is defined as a period in time during which a single or multiple transmissions may occur and which shall be followed by a Tx-gap. These multiple transmissions within a single Tx-sequence may take place on the same hopping frequency or on multiple hopping frequencies.

Tx-gap is defined as a period in time during which no transmissions occur on any of the hopping frequencies.

For non-adaptive frequency hopping equipment, the maximum Duty Cycle at which the equipment can operate, is declared by the manufacturer. The equipment may have a dynamic behaviour with regard to duty cycle and corresponding power level. See clause 5.4.1 e).

4.3.1.3.3 Limit

For non-adaptive FHSS equipment, the Duty Cycle shall be equal to or less than the maximum value declared by the manufacturer. In addition, the maximum Tx-sequence time shall be 5 ms while the minimum Tx-gap time shall be 5 ms.

4.3.1.3.4 Conformance

The conformance tests for this requirement are defined in clause 5.4.2 and specifically in clause 5.4.2.2.1.3.

4.3.1.4 Accumulated Transmit Time, Frequency Occupation and Hopping Sequence

4.3.1.4.1 Applicability

These requirements apply to all types of frequency hopping equipment.

4.3.1.4.2 Definition

The Accumulated Transmit Time is the total of the transmitter 'on' times, during an observation period, on a particular hopping frequency.

The Frequency Occupation is the number of times that each hopping frequency is occupied within a given period. A hopping frequency is considered to be occupied when the equipment selects that frequency from the hopping sequence. The equipment may be transmitting, receiving or stay idle during the Dwell Time spent on that hopping frequency.

The Hopping Sequence of a frequency hopping equipment is the unrepeated pattern of the hopping frequencies used by the equipment.

4.3.1.4.3 Limit

4.3.1.4.3.1 Non-adaptive frequency hopping equipment

The Accumulated Transmit Time on any hopping frequency shall not be greater than 15 ms within any observation period of 15 ms multiplied by the minimum number of hopping frequencies (N) that have to be used.

In order for the equipment to comply with the Frequency Occupation requirement, it shall meet either of the following two options:

- Option 1: Each hopping frequency of the hopping sequence shall be occupied at least once within a period not exceeding four times the product of the dwell time and the number of hopping frequencies in use.
- Option 2: The occupation probability for each frequency shall be between $((1 / U) \times 25 \%)$ and 77 % where U is the number of hopping frequencies in use.

The hopping sequence(s) shall contain at least N hopping frequencies where N is either 5 or the result of 15 MHz divided by the minimum Hopping Frequency Separation in MHz, whichever is the greater. According to clause 4.3.1.5.3.1 the minimum Hopping Frequency Separation for non-adaptive equipment is equal to the Occupied Channel Bandwidth with a minimum of 100 kHz.

4.3.1.4.3.2 Adaptive frequency hopping equipment

Adaptive Frequency Hopping equipment shall be capable of operating over a minimum of 70 % of the band specified in table 1.

The Accumulated Transmit Time on any hopping frequency shall not be greater than 400 ms within any observation period of 400 ms multiplied by the minimum number of hopping frequencies (N) that have to be used.

In order for the equipment to comply with the Frequency Occupation requirement, it shall meet either of the following two options:

- Option 1: Each hopping frequency of the hopping sequence shall be occupied at least once within a period not exceeding four times the product of the dwell time and the number of hopping frequencies in use.
- Option 2: The occupation probability for each frequency shall be between $((1 / U) \times 25 \%)$ and 77 % where U is the number of hopping frequencies in use.

The hopping sequence(s) shall contain at least N hopping frequencies at all times, where N is either 15 or the result of 15 MHz divided by the minimum Hopping Frequency Separation in MHz, whichever is the greater.

4.3.1.4.4 Other Requirements

For non-Adaptive Frequency Hopping equipment, from the N hopping frequencies defined in clause 4.3.1.4.3.1 above, the equipment shall transmit on at least one hopping frequency while other hopping frequencies are blacklisted.

For equipment that blacklists one or more hopping frequencies, these blacklisted frequencies are considered as active transmitting for the calculation of the MU factor of the equipment. See also clause 5.4.2.2.1.3, step 4, first bullet item and clause 5.4.2.2.1.4, step 3, first bullet item, second paragraph.

For Adaptive Frequency Hopping equipment, from the N hopping frequencies defined in clause 4.3.1.4.3.2 above, the equipment shall consider at least one hopping frequency for its transmissions. Providing that there is no interference present on this hopping frequency with a level above the detection threshold defined in clause 4.3.1.7.2.2, point 5 or clause 4.3.1.7.3.2, point 5, then the equipment shall have transmissions on this hopping frequency.

For non-Adaptive Frequency Hopping equipment, when not transmitting on a hopping frequency, the equipment has to occupy that frequency for the duration of the typical dwell time (see also definition for blacklisted frequency in clause 3.1).

For Adaptive Frequency Hopping equipment using LBT based DAA, if a signal is detected during the CCA, the equipment may jump immediately to the next frequency in the hopping sequence (see clause 4.3.1.7.2.2, point 2) provided the limit for maximum dwell time is respected.

4.3.1.4.5 Conformance

The conformance tests for this requirement are defined in clause 5.4.4. Alternatively, for demonstrating compliance with the Accumulated Transmit Time requirement, the manufacturer may provide a statistical analysis to demonstrate that the requirement can be met with a probability of 95 %. See clause 5.4.1.

For equipment implementing Option 1 in clause 4.3.1.4.3.1 or Option 1 in clause 4.3.1.4.3.2, in case compliance cannot be proven via measurements in clause 5.4.4.2.1, step 5 (as the Frequency Occupation in receive and idle modes cannot be measured), the manufacturer shall provide a statistical analysis to demonstrate compliance with the Frequency Occupation requirement. This statistical analysis may be performed by simulation or mathematical analysis.

For equipment using Option 2 in clause 4.3.1.4.3.1 or Option 2 in clause 4.3.1.4.3.2, the manufacturer shall provide a statistical analysis to demonstrate compliance with this requirement. This statistical analysis may be performed by simulation or mathematical analysis.

4.3.1.5 Hopping Frequency Separation

4.3.1.5.1 Applicability

This requirement applies to all types of frequency hopping equipment.

4.3.1.5.2 Definition

The Hopping Frequency Separation is the frequency separation between two adjacent hopping frequencies.

4.3.1.5.3 Limit

4.3.1.5.3.1 Non-adaptive frequency hopping equipment

For non-adaptive Frequency Hopping equipment, the Hopping Frequency Separation shall be equal to or greater than the Occupied Channel Bandwidth (see clause 4.3.1.8), with a minimum separation of 100 kHz.

For equipment with a maximum declared RF Output power level of less than 10 dBm e.i.r.p. or for non-adaptive Frequency Hopping equipment operating in a mode where the RF Output power is less than 10 dBm e.i.r.p. only the minimum Hopping Frequency Separation of 100 kHz applies.

4.3.1.5.3.2 Adaptive frequency hopping equipment

For adaptive Frequency Hopping equipment, the minimum Hopping Frequency Separation shall be 100 kHz.

Adaptive Frequency Hopping equipment that switched to a non-adaptive mode for one or more hopping frequencies because interference was detected on these hopping frequencies with a level above the threshold level defined in clause 4.3.1.7.2.2, point 5 or clause 4.3.1.7.3.2, point 5, is allowed to continue to operate with a minimum Hopping Frequency Separation of 100 kHz as long as the interference remains present on these hopping frequencies. The equipment shall continue to operate in an adaptive mode on other hopping frequencies.

Adaptive Frequency Hopping equipment which decided to operate in a non-adaptive mode on one or more hopping frequencies without the presence of interference, shall comply with the limit for Hopping Frequency Separation for non-adaptive equipment defined in clause 4.3.1.5.3.1 (first paragraph) for these hopping frequencies as well as with all other requirements applicable to non-adaptive frequency hopping equipment.

4.3.1.5.4 Conformance

The conformance tests for this requirement are defined in clause 5.4.5.

4.3.1.6 Medium Utilization (MU) factor

4.3.1.6.1 Applicability

This requirement does not apply to adaptive equipment unless operating in a non-adaptive mode.

In addition, this requirement does not apply for equipment with a maximum declared RF Output power level of less than 10 dBm e.i.r.p. or for equipment when operating in a mode where the RF Output power is less than 10 dBm e.i.r.p.

4.3.1.6.2 Definition

The Medium Utilization (MU) factor is a measure to quantify the amount of resources (Power and Time) used by non-adaptive equipment. The Medium Utilization factor is defined by the formula:

$$\text{MU} = (\text{P} / 100 \text{ mW}) \times \text{DC}$$

where: MU is Medium Utilization factor in %.

P is the RF output power as defined in clause 4.3.1.2.2 expressed in mW.

DC is the Duty Cycle as defined in clause 4.3.1.3.2 expressed in %.

The equipment may have dynamic behaviour with regard to duty cycle and corresponding power level. See clause 5.4.1 e).

4.3.1.6.3 Limit

The maximum Medium Utilization factor for non-adaptive Frequency Hopping equipment shall be 10 %.

4.3.1.6.4 Conformance

The conformance tests for this requirement are defined in clause 5.4.2 and specifically in clause 5.4.2.2.1.4.

4.3.1.7 Adaptivity (Adaptive Frequency Hopping)

4.3.1.7.1 Applicability

This requirement does not apply to non-adaptive equipment or adaptive equipment operating in a non-adaptive mode providing the equipment complies with the requirements and/or restrictions applicable to non-adaptive equipment.

In addition, this requirement does not apply for equipment with a maximum declared RF Output power level of less than 10 dBm e.i.r.p. or for equipment when operating in a mode where the RF Output power is less than 10 dBm e.i.r.p.

Adaptive Frequency Hopping equipment is allowed to operate in a non-adaptive mode providing it complies with the requirements applicable to non-adaptive frequency hopping equipment. See also clause 4.3.1.5.3.2.

Adaptive Frequency Hopping equipment is allowed to have Short Control Signalling Transmissions (e.g. ACK/NACK signals, etc.) without sensing the frequency for the presence of other signals. See clause 4.3.1.7.4.

Adaptive Frequency Hopping (AFH) equipment uses a Detect And Avoid (DAA) mechanism which allows an equipment to adapt to its radio environment by identifying frequencies that are being used by other equipment.

Adaptive Frequency Hopping equipment shall implement either of the DAA mechanisms provided in clause 4.3.1.7.2 or clause 4.3.1.7.3.

Adaptive equipment is allowed to switch dynamically between different adaptive modes.

4.3.1.7.2 Adaptive Frequency Hopping using LBT based DAA

4.3.1.7.2.1 Definition

Adaptive Frequency Hopping using LBT based DAA is a mechanism by which a given hopping frequency is made 'unavailable' because an interfering signal was detected before any transmission on that frequency. This mechanism shall operate as intended in the presence of an unwanted signal on frequencies other than those of the operating band.

4.3.1.7.2.2 Requirements & Limits

Adaptive Frequency Hopping equipment using LBT based DAA shall comply with the following minimum set of requirements:

- 1) At the start of every dwell time, before transmission on a hopping frequency, the equipment shall perform a Clear Channel Assessment (CCA) check using energy detect. The CCA observation time shall be not less than 0,2 % of the Channel Occupancy Time with a minimum of 18 μ s. If the equipment finds the hopping frequency to be clear, it may transmit immediately.
- 2) If it is determined that a signal is present with a level above the detection threshold defined in step 5 the hopping frequency shall be marked as 'unavailable'. Then the equipment may jump to the next frequency in the hopping scheme even before the end of the dwell time, but in that case the 'unavailable' channel cannot be considered as being 'occupied' and shall be disregarded with respect to the requirement of the minimum number of hopping frequencies as defined in clause 4.3.1.4.3.2. Alternatively, the equipment can remain on the frequency during the remainder of the dwell time. However, if the equipment remains on the frequency with the intention to transmit, it shall perform an Extended CCA check in which the (unavailable) channel is observed for a random duration between the value defined for the CCA observation time in step 1 and 5 % of the Channel Occupancy Time defined in step 3. If the Extended CCA check has determined the frequency to be no longer occupied, the hopping frequency becomes available again. If the Extended CCA time has determined the channel still to be occupied, it shall perform new Extended CCA checks until the channel is no longer occupied.
- 3) The total time during which an equipment has transmissions on a given hopping frequency without re-evaluating the availability of that frequency is defined as the Channel Occupancy Time.

The Channel Occupancy Time for a given hopping frequency, which starts immediately after a successful CCA, shall be less than 60 ms followed by an Idle Period of minimum 5 % of the Channel Occupancy Time with a minimum of 100 μ s.

After the Idle Period has expired, the procedure as in step 1 shall be repeated before having new transmissions on this hopping frequency during the same dwell time.

EXAMPLE: An equipment with a dwell time of 400 ms can have 6 transmission sequences of 60 ms each, separated with an Idle Period of 3 ms. Each transmission sequence was preceded with a successful CCA check of 120 μ s.

For LBT based adaptive frequency hopping equipment with a dwell time < 60 ms, the maximum Channel Occupancy Time is limited by the dwell time.

- 4) 'Unavailable' channels may be removed from or may remain in the hopping sequence, but in any case:
 - apart from Short Control Signalling Transmissions referred to in clause 4.3.1.7.4, there shall be no transmissions on 'unavailable' channels;
 - a minimum of N hopping frequencies as defined in clause 4.3.1.4.3.2 shall always be maintained.
- 5) The detection threshold shall be proportional to the transmit power of the transmitter: for a 20 dBm e.i.r.p. transmitter the detection threshold level (TL) shall be equal to or less than -70 dBm/MHz at the input to the receiver assuming a 0 dBi (receive) antenna assembly. This threshold level (TL) may be corrected for the (receive) antenna assembly gain (G); however, beamforming gain (Y) shall not be taken into account. For power levels less than 20 dBm e.i.r.p., the detection threshold level may be relaxed to:

$$TL = -70 \text{ dBm/MHz} + 10 \times \log_{10} (100 \text{ mW} / P_{out}) \quad (P_{out} \text{ in mW e.i.r.p.})$$
- 6) The equipment shall comply with the requirements defined in step 1 to step 4 of the present clause in the presence of an unwanted CW signal as defined in table 2.

Table 2: Unwanted Signal parameters

Wanted signal mean power from companion device	Unwanted signal frequency (MHz)	Unwanted CW signal power (dBm)
sufficient to maintain the link (see note 2)	2 395 or 2 488,5 (see note 1)	-35 (see note 3)
<p>NOTE 1: The highest frequency shall be used for testing operating channels within the range 2 400 MHz to 2 442 MHz, while the lowest frequency shall be used for testing operating channels within the range 2 442 MHz to 2 483,5 MHz. See clause 5.4.6.1.</p> <p>NOTE 2: A typical value which can be used in most cases is -50 dBm/MHz.</p> <p>NOTE 3: The level specified is the level in front of the UUT antenna. In case of conducted measurements, this level has to be corrected by the actual antenna assembly gain.</p>		

4.3.1.7.2.3 Conformance

The conformance tests for this requirement are defined in clause 5.4.6 and specifically in clause 5.4.6.2.1.2.

4.3.1.7.3 Adaptive Frequency Hopping using other forms of DAA (non-LBT based)

4.3.1.7.3.1 Definition

Adaptive Frequency Hopping using other forms of DAA is a mechanism different from LBT, by which a given hopping frequency is made 'unavailable' because an interfering signal was reported after transmissions on that frequency. This mechanism shall operate as intended in the presence of an unwanted signal on frequencies other than those of the operating band.

4.3.1.7.3.2 Requirements & Limits

Adaptive Frequency Hopping equipment using non-LBT based DAA, shall comply with the following minimum set of requirements:

- 1) During normal operation, the equipment shall evaluate the presence of a signal for each of its hopping frequencies. If it is determined that a signal is present with a level above the detection threshold defined in step 5 the hopping frequency shall be marked as 'unavailable'.
- 2) The hopping frequency shall remain unavailable for a minimum time equal to 1 second or 5 times the actual number of hopping frequencies in the current (adapted) channel map used by the equipment, multiplied with the Channel Occupancy Time whichever is greater. There shall be no transmissions during this period on this hopping frequency. After this, the hopping frequency may be considered again as an 'available' frequency.
- 3) The total time during which an equipment has transmissions on a given hopping frequency without re-evaluating the availability of that hopping frequency is defined as the Channel Occupancy Time.

The Channel Occupancy Time for a given hopping frequency shall be less than 40 ms. For equipment using a dwell time > 40 ms that wants to have other transmissions during the same hop (dwell time) an Idle Period (no transmissions) of minimum 5 % of the Channel Occupancy Period with a minimum of 100 μ s shall be implemented.

After the Idle Period has expired, the procedure as in step 1 needs to be repeated before having new transmissions on this hopping frequency during the same dwell time.

EXAMPLE: An equipment with a dwell time of 400 ms can have 9 transmission sequences of 40 ms each, separated with an Idle Period of 3 ms.

For non-LBT based frequency hopping equipment with a dwell time < 40 ms, the maximum Channel Occupancy Time may be non-contiguous, i.e. spread over a number of hopping sequences (equal to 40 ms divided by the dwell time [ms]).

- 4) 'Unavailable' channels may be removed from or may remain in the hopping sequence, but in any case:
- apart from the Short Control Signalling Transmissions referred to in clause 4.3.1.7.4, there shall be no transmissions on 'unavailable' channels;
 - a minimum of N hopping frequencies as defined in clause 4.3.1.4.3.2 shall always be maintained.
- 5) The detection threshold shall be proportional to the transmit power of the transmitter: for a 20 dBm e.i.r.p. transmitter the detection threshold level (TL) shall be equal to or less than -70 dBm/MHz at the input to the receiver assuming a 0 dBi (receive) antenna assembly. This threshold level (TL) may be corrected for the (receive) antenna assembly gain (G); however, beamforming gain (Y) shall not be taken into account. For power levels below 20 dBm e.i.r.p., the detection threshold level may be relaxed to:
- $$TL = -70 \text{ dBm/MHz} + 10 \times \log_{10} (100 \text{ mW} / P_{out}) \quad (P_{out} \text{ in mW e.i.r.p.})$$
- 6) The equipment shall comply with the requirements defined in step 1 to step 4 of the present clause in the presence of an unwanted CW signal as defined in table 3.

Table 3: Unwanted Signal parameters

Wanted signal mean power from companion device (dBm)	Unwanted signal frequency (MHz)	Unwanted CW signal power (dBm)
-30	2 395 or 2 488,5 (see note 1)	-35 (see note 2)
NOTE 1: The highest frequency shall be used for testing operating channels within the range 2 400 MHz to 2 442 MHz, while the lowest frequency shall be used for testing operating channels within the range 2 442 MHz to 2 483,5 MHz. See clause 5.4.6.1.		
NOTE 2: The level specified is the level in front of the UUT antenna. In case of conducted measurements, this level has to be corrected by the actual antenna assembly gain.		

4.3.1.7.3.3 Conformance

The conformance tests for this requirement are defined in clause 5.4.6 and specifically in clause 5.4.6.2.1.2.

4.3.1.7.4 Short Control Signalling Transmissions

4.3.1.7.4.1 Definition

Short Control Signalling Transmissions are transmissions used by Adaptive Frequency Hopping equipment to send control signals (e.g. ACK/NACK signals, etc.) without sensing the frequency for the presence of other signals.

Adaptive equipment may or may not have Short Control Signalling Transmissions.

4.3.1.7.4.2 Limits

If implemented, Short Control Signalling Transmissions shall have a maximum TxOn / (TxOn + TxOff) ratio of 10 % within any observation period of 50 ms or within an observation period equal to the dwell time, whichever is less.

4.3.1.7.4.3 Conformance

The conformance tests for this requirement are part of the procedure for the Adaptivity testing defined in clause 5.4.6.2.1.2.

4.3.1.8 Occupied Channel Bandwidth

4.3.1.8.1 Applicability

This requirement applies to all types of frequency hopping equipment.

4.3.1.8.2 Definition

The Occupied Channel Bandwidth is the bandwidth that contains 99 % of the power of the signal when considering a single hopping frequency.

4.3.1.8.3 Limits

The Occupied Channel Bandwidth for each hopping frequency shall fall completely within the band given in table 1.

For non-adaptive Frequency Hopping equipment with e.i.r.p. greater than 10 dBm, the Occupied Channel Bandwidth for every occupied hopping frequency shall be equal to or less than the Nominal Channel Bandwidth declared by the manufacturer. See clause 5.4.1 j). This declared value shall not be greater than 5 MHz.

4.3.1.8.4 Conformance

The conformance tests for this requirement are defined in clause 5.4.7.

4.3.1.9 Transmitter unwanted emissions in the out-of-band domain

4.3.1.9.1 Applicability

This requirement applies to all types of frequency hopping equipment.

4.3.1.9.2 Definition

Transmitter unwanted emissions in the out-of-band domain are emissions when the equipment is in Transmit mode, on frequencies immediately outside the necessary bandwidth which results from the modulation process, but excluding spurious emissions.

4.3.1.9.3 Limit

The transmitter unwanted emissions in the out-of-band domain but outside the allocated band, shall not exceed the values provided by the mask in figure 1.

Within the band specified in table 1, the Out-of-band emissions are fulfilled by compliance with the Occupied Channel Bandwidth requirement in clause 4.3.1.8.

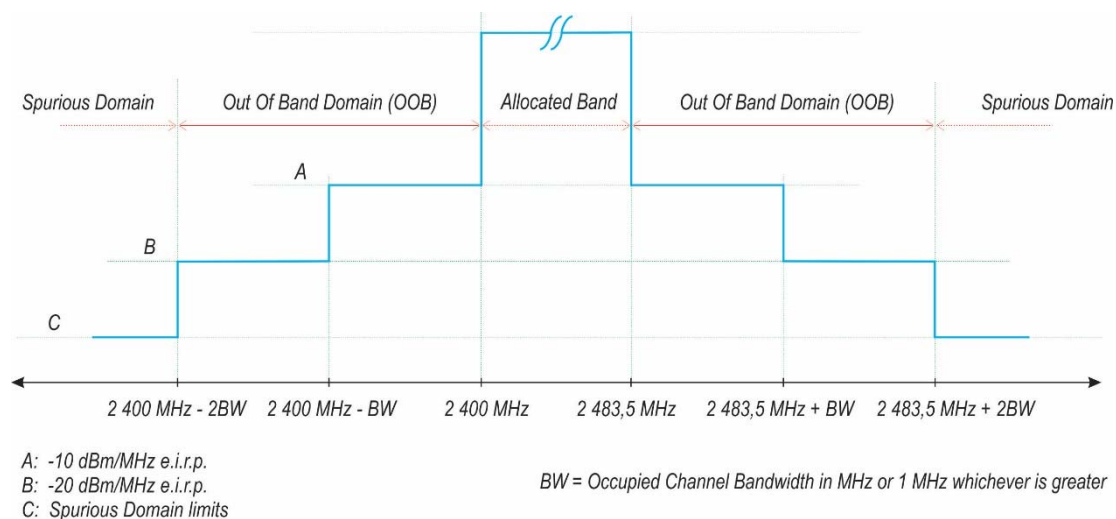

Figure 1: Transmit mask

4.3.1.9.4 Conformance

The conformance tests for this requirement are defined in clause 5.4.8.

4.3.1.10 Transmitter unwanted emissions in the spurious domain

4.3.1.10.1 Applicability

This requirement applies to all types of frequency hopping equipment.

4.3.1.10.2 Definition

Transmitter unwanted emissions in the spurious domain are emissions outside the allocated band and outside the out-of-band domain as indicated in figure 1 when the equipment is in Transmit mode.

4.3.1.10.3 Limit

The transmitter unwanted emissions in the spurious domain shall not exceed the values given in table 4.

In case of equipment with antenna connectors, these limits apply to emissions at the antenna port (conducted). For emissions radiated by the cabinet or emissions radiated by integral antenna equipment (without antenna connectors), these limits are e.r.p. for emissions up to 1 GHz and e.i.r.p. for emissions above 1 GHz.

Table 4: Transmitter limits for spurious emissions

Frequency range	Maximum power	Bandwidth
30 MHz to 47 MHz	-36 dBm	100 kHz
47 MHz to 74 MHz	-54 dBm	100 kHz
74 MHz to 87,5 MHz	-36 dBm	100 kHz
87,5 MHz to 118 MHz	-54 dBm	100 kHz
118 MHz to 174 MHz	-36 dBm	100 kHz
174 MHz to 230 MHz	-54 dBm	100 kHz
230 MHz to 470 MHz	-36 dBm	100 kHz
470 MHz to 862 MHz	-54 dBm	100 kHz
862 MHz to 1 GHz	-36 dBm	100 kHz
1 GHz to 12,75 GHz	-30 dBm	1 MHz

4.3.1.10.4 Conformance

The conformance tests for this requirement are defined in clause 5.4.9.

4.3.1.11 Receiver spurious emissions

4.3.1.11.1 Applicability

This requirement applies to all types of frequency hopping equipment.

4.3.1.11.2 Definition

Receiver spurious emissions are emissions at any frequency when the equipment is in receive mode.

4.3.1.11.3 Limit

The spurious emissions of the receiver shall not exceed the values given in table 5.

In case of equipment with antenna connectors, these limits apply to emissions at the antenna port (conducted). For emissions radiated by the cabinet or emissions radiated by integral antenna equipment (without antenna connectors), these limits are e.r.p. for emissions up to 1 GHz and e.i.r.p. for emissions above 1 GHz.

Table 5: Spurious emission limits for receivers

Frequency range	Maximum power	Bandwidth
30 MHz to 1 GHz	-57 dBm	100 kHz
1 GHz to 12,75 GHz	-47 dBm	1 MHz

4.3.1.11.4 Conformance

The conformance tests for this requirement are defined in clause 5.4.10.

4.3.1.12 Receiver Blocking

4.3.1.12.1 Applicability

This requirement applies to all receiver categories as defined in clause 4.2.3.

4.3.1.12.2 Definition

Receiver blocking is a measure of the ability of the equipment to receive a wanted signal on its operating channel without exceeding a given degradation in the presence of an unwanted signal (blocking signal) on frequencies other than those of the operating band provided in table 1.

4.3.1.12.3 Performance Criteria

The minimum performance criterion shall be a PER less than or equal to 10 %. The manufacturer may declare alternative performance criteria as long as that is appropriate for the intended use of the equipment (see clause 5.4.1.t)).

4.3.1.12.4 Limits

4.3.1.12.4.1 General

While maintaining the minimum performance criteria as defined in clause 4.3.1.12.3, the blocking levels at specified frequency offsets shall be equal to or greater than the limits defined for the applicable receiver category provided in table 6, table 7 or table 8.

4.3.1.12.4.2 Receiver Category 1

Table 6 contains the Receiver Blocking parameters for Receiver Category 1 equipment.

Table 6: Receiver Blocking parameters for Receiver Category 1 equipment

Wanted signal mean power from companion device (dBm)	Blocking signal frequency (MHz)	Blocking signal power (dBm) (see note 2)	Type of blocking signal
$P_{\min} + 6$ dB	2 380 2 503,5	-53	CW
$P_{\min} + 6$ dB	2 300 2 330 2 360	-47	CW
$P_{\min} + 6$ dB	2 523,5 2 553,5 2 583,5 2 613,5 2 643,5 2 673,5	-47	CW
NOTE 1: P_{\min} is the minimum level of wanted signal (in dBm) required to meet the minimum performance criteria as defined in clause 4.3.1.12.3 in the absence of any blocking signal.			
NOTE 2: The levels specified are levels in front of the UUT antenna. In case of conducted measurements, the levels have to be corrected by the actual antenna assembly gain.			

4.3.1.12.4.3 Receiver Category 2

Table 7 contains the Receiver Blocking parameters for Receiver Category 2 equipment.

Table 7: Receiver Blocking parameters receiver category 2 equipment

Wanted signal mean power from companion device (dBm)	Blocking signal frequency (MHz)	Blocking signal power (dBm) (see note 2)	Type of blocking signal
$P_{\min} + 6$ dB	2 380 2 503,5	-57	CW
$P_{\min} + 6$ dB	2 300 2 583,5	-47	CW
NOTE 1: P_{\min} is the minimum level of the wanted signal (in dBm) required to meet the minimum performance criteria as defined in clause 4.3.1.12.3 in the absence of any blocking signal.			
NOTE 2: The levels specified are levels in front of the UUT antenna. In case of conducted measurements, the levels have to be corrected by the actual antenna assembly gain.			

4.3.1.12.4.4 Receiver Category 3

Table 8 contains the Receiver Blocking parameters for Receiver Category 3 equipment.

Table 8: Receiver Blocking parameters receiver category 3 equipment

Wanted signal mean power from companion device (dBm)	Blocking signal frequency (MHz)	Blocking signal power (dBm) (see note 2)	Type of blocking signal
$P_{\min} + 12$ dB	2 380 2 503,5	-57	CW
$P_{\min} + 12$ dB	2 300 2 583,5	-47	CW
NOTE 1: P_{\min} is the minimum level of the wanted signal (in dBm) required to meet the minimum performance criteria as defined in clause 4.3.1.12.3 in the absence of any blocking signal.			
NOTE 2: The levels specified are levels in front of the UUT antenna. In case of conducted measurements, the levels have to be corrected by the actual antenna assembly gain.			

4.3.1.12.5 Conformance

The conformance tests for this requirement are defined in clause 5.4.11.

4.3.1.13 Geo-location capability

4.3.1.13.1 Applicability

This requirement only applies to equipment with geo-location capability as defined in clause 4.3.1.13.2.

4.3.1.13.2 Definition

Geo-location capability is a feature of the equipment to determine its geographical location with the purpose to configure itself according to the regulatory requirements applicable at the geographical location where it operates.

The geo-location capability may be present in the equipment or in an external device (temporary) associated with the equipment operating at the same geographical location during the initial power up of the equipment. The geographical location may also be available in equipment already installed and operating at the same geographical location.

4.3.1.13.3 Requirements

The geographical location determined by the equipment as defined in clause 4.3.1.13.2 shall not be accessible to the user.

4.3.2 Requirements for other types of Wide Band modulation

4.3.2.1 Introduction

Equipment using wide band modulations other than FHSS is equipment that typically operates on a fixed frequency. This equipment shall comply with the requirements in clause 4.3.2.2 to clause 4.3.2.12.

The equipment is allowed to change its normal operating frequency when interference is detected, or to prevent causing interference into other equipment or for frequency planning purposes.

For equipment using FHSS modulation, the requirements in clause 4.3.1 shall apply.

4.3.2.2 RF output power

4.3.2.2.1 Applicability

This requirement applies to all types of equipment using wide band modulations other than FHSS.

4.3.2.2.2 Definition

The RF output power is defined as the mean equivalent isotropic radiated power (e.i.r.p.) of the equipment during a transmission burst.

4.3.2.2.3 Limit

For adaptive equipment using wide band modulations other than FHSS, the maximum RF output power shall be 20 dBm.

The maximum RF output power for non-adaptive equipment shall be declared by the manufacturer and shall not exceed 20 dBm. See clause 5.4.1 m). For non-adaptive equipment using wide band modulations other than FHSS, the maximum RF output power shall be equal to or less than the value declared by the manufacturer.

This limit shall apply for any combination of power level and intended antenna assembly.

4.3.2.2.4 Conformance

The conformance tests for this requirement are defined in clause 5.4.2 and specifically, in clause 5.4.2.2.1.2.

4.3.2.3 Power Spectral Density

4.3.2.3.1 Applicability

This requirement applies to all types of equipment using wide band modulations other than FHSS.

4.3.2.3.2 Definition

The Power Spectral Density (PSD) is the mean equivalent isotropically radiated power (e.i.r.p.) spectral density in a 1 MHz bandwidth during a transmission burst.

4.3.2.3.3 Limit

For equipment using wide band modulations other than FHSS, the maximum Power Spectral Density is limited to 10 dBm per MHz.

4.3.2.3.4 Conformance

The conformance tests for this requirement are defined in clause 5.4.3.

4.3.2.4 Duty Cycle, Tx-sequence, Tx-gap

4.3.2.4.1 Applicability

These requirements apply to non-adaptive equipment or to adaptive equipment when operating in a non-adaptive mode. The equipment is using wide band modulations other than FHSS.

These requirements do not apply for equipment with a maximum declared RF Output power level of less than 10 dBm e.i.r.p. or for equipment when operating in a mode where the RF Output power is less than 10 dBm e.i.r.p.

4.3.2.4.2 Definition

Duty Cycle is defined as the ratio of the total transmitter 'on'-time to a 1 second observation period.

Tx-sequence is defined as a period in time during which a single or multiple transmissions may occur and which shall be followed by a Tx-gap.

Tx-gap is defined as a period in time during which no transmissions occur.

The maximum Duty Cycle at which the equipment can operate, is declared by the manufacturer.

4.3.2.4.3 Limit

The Duty Cycle shall be equal to or less than the maximum value declared by the manufacturer.

The Tx-sequence time shall be equal to or less than 10 ms. The minimum Tx-gap time following a Tx-sequence shall be equal to the duration of that preceding Tx-sequence with a minimum of 3,5 ms.

4.3.2.4.4 Conformance

The conformance tests for this requirement are defined in clause 5.4.2 and specifically in clause 5.4.2.2.1.3.

4.3.2.5 Medium Utilization (MU) factor

4.3.2.5.1 Applicability

This requirement does not apply to adaptive equipment unless operating in a non-adaptive mode.

In addition, this requirement does not apply for equipment with a maximum declared RF Output power level of less than 10 dBm e.i.r.p. or for equipment when operating in a mode where the RF Output power is less than 10 dBm e.i.r.p.

4.3.2.5.2 Definition

The Medium Utilization (MU) factor is a measure to quantify the amount of resources (Power and Time) used by non-adaptive equipment. The Medium Utilization factor is defined by the formula:

$$MU = (P / 100 \text{ mW}) \times DC$$

where: MU is Medium Utilization.

P is the RF output power as defined in clause 4.3.2.2.2 expressed in mW.

DC is the Duty Cycle as defined in clause 4.3.2.4.2 expressed in %.

The equipment may have dynamic behaviour with regard to duty cycle and corresponding power level. See clause 5.4.1 e).

4.3.2.5.3 Limit

For non-adaptive equipment using wide band modulations other than FHSS, the maximum Medium Utilization factor shall be 10 %.

4.3.2.5.4 Conformance

The conformance tests for this requirement are defined in clause 5.4.2 and specifically in clause 5.4.2.2.1.4.

4.3.2.6 Adaptivity (adaptive equipment using modulations other than FHSS)

4.3.2.6.1 Applicability

This requirement does not apply to non-adaptive equipment or adaptive equipment operating in a non-adaptive mode providing the equipment complies with the requirements and/or restrictions applicable to non-adaptive equipment.

In addition, this requirement does not apply for equipment with a maximum declared RF Output power level of less than 10 dBm e.i.r.p. or for equipment when operating in a mode where the RF Output power is less than 10 dBm e.i.r.p.

Adaptive equipment using modulations other than FHSS is allowed to operate in a non-adaptive mode providing it complies with the requirements applicable to non-adaptive equipment.

An adaptive equipment using modulations other than FHSS is equipment that uses a mechanism by which it can adapt to its radio environment by identifying other transmissions present within its Occupied Channel Bandwidth.

Adaptive equipment using modulations other than FHSS shall implement either of the Detect and Avoid mechanisms provided in clause 4.3.2.6.2 or clause 4.3.2.6.3.

Adaptive equipment is allowed to switch dynamically between different adaptive modes.

4.3.2.6.2 Non-LBT based Detect and Avoid

4.3.2.6.2.1 Definition

Non-LBT based Detect and Avoid is a mechanism for equipment using wide band modulations other than FHSS and by which a given channel is made 'unavailable' because an interfering signal was reported after the transmission in that channel. This mechanism shall operate as intended in the presence of an unwanted signal on frequencies other than those of the operating band.

4.3.2.6.2.2 Requirements & Limits

Equipment using a modulation other than FHSS and using the non-LBT based Detect and Avoid mechanism, shall comply with the following minimum set of requirements:

- 1) During normal operation, the equipment shall evaluate the presence of a signal on its current operating channel. If it is determined that a signal is present with a level above the detection threshold defined in step 5 the channel shall be marked as 'unavailable'.
- 2) The channel shall remain unavailable for a minimum time equal to 1 s after which the channel may be considered again as an 'available' channel.
- 3) The total time during which an equipment has transmissions on a given channel without re-evaluating the availability of that channel, is defined as the Channel Occupancy Time.
- 4) The Channel Occupancy Time shall be less than 40 ms. Each such transmission sequence shall be followed by an Idle Period (no transmissions) of minimum 5 % of the Channel Occupancy Time with a minimum of 100 μ s. After this, the procedure as in step 1 needs to be repeated.

- 5) The detection threshold shall be proportional to the transmit power of the transmitter: for a 20 dBm e.i.r.p. transmitter the detection threshold level (TL) shall be equal to or less than -70 dBm/MHz at the input to the receiver assuming a 0 dBi (receive) antenna assembly. This threshold level (TL) may be corrected for the (receive) antenna assembly gain (G); however, beamforming gain (Y) shall not be taken into account. For power levels less than 20 dBm e.i.r.p., the detection threshold level may be relaxed to:

$$TL = -70 \text{ dBm/MHz} + 10 \times \log_{10} (100 \text{ mW} / P_{out}) \quad (P_{out} \text{ in mW e.i.r.p.})$$

- 6) The equipment shall comply with the requirements defined in step 1 to step 4 of the present clause in the presence of an unwanted CW signal as defined in table 9.

Table 9: Unwanted Signal parameters

Wanted signal mean power from companion device (dBm)	Unwanted signal frequency (MHz)	Unwanted CW signal power (dBm)
-30	2 395 or 2 488,5 (see note 1)	-35 (see note 2)
NOTE 1: The highest frequency shall be used for testing operating channels within the range 2 400 MHz to 2 442 MHz, while the lowest frequency shall be used for testing operating channels within the range 2 442 MHz to 2 483,5 MHz. See clause 5.4.6.1.		
NOTE 2: The level specified is the level in front of the UUT antenna. In case of conducted measurements, this level has to be corrected by the actual antenna assembly gain.		

4.3.2.6.2.3 Conformance

The conformance tests for this requirement are defined in clause 5.4.6 and specifically in clause 5.4.6.2.1.3.

4.3.2.6.3 LBT based Detect and Avoid

4.3.2.6.3.1 Definition

LBT based Detect and Avoid is a mechanism by which equipment using wide band modulations other than FHSS, avoids transmissions in a channel in the presence of an interfering signal in that channel. This mechanism shall operate as intended in the presence of an unwanted signal on frequencies other than those of the operating band.

4.3.2.6.3.2 Requirements & Limits

4.3.2.6.3.2.1 Introduction

The present document defines two types of adaptive equipment using wide band modulations other than FHSS and that uses an LBT based Detect and Avoid mechanism: Frame Based Equipment and Load Based Equipment.

Adaptive equipment which is capable of operating as either Load Based Equipment or as Frame Based Equipment is allowed to switch dynamically between these types of operation.

4.3.2.6.3.2.2 Frame Based Equipment

Frame Based Equipment shall comply with the following requirements:

- 1) Before transmission, the equipment shall perform a Clear Channel Assessment (CCA) check using energy detect. The equipment shall observe the operating channel for the duration of the CCA observation time which shall be not less than 18 μ s. The channel shall be considered occupied if the energy level in the channel exceeds the threshold given in step 5 below. If the equipment finds the channel to be clear, it may transmit immediately. See figure 2 below.
- 2) If the equipment finds the channel occupied, it shall not transmit on this channel during the next Fixed Frame Period.

The equipment is allowed to switch to a non-adaptive mode and to continue transmissions on this channel providing it complies with the requirements applicable to non-adaptive equipment. See clause 4.3.2.6.1. Alternatively, the equipment is also allowed to continue Short Control Signalling Transmissions on this channel providing it complies with the requirements given in clause 4.3.2.6.4.

- 3) The total time during which an equipment has transmissions on a given channel without re-evaluating the availability of that channel, is defined as the Channel Occupancy Time.

The Channel Occupancy Time shall be in the range 1 ms to 10 ms followed by an Idle Period of at least 5 % of the Channel Occupancy Time used in the equipment for the current Fixed Frame Period. See figure 2 below.

- 4) An equipment, upon correct reception of a packet which was intended for this equipment can skip CCA and immediately (see also next paragraph) proceed with the transmission of management and control frames (e.g. ACK and Block ACK frames are allowed but data frames are not allowed). A consecutive sequence of such transmissions by the equipment without a new CCA shall not exceed the maximum Channel Occupancy Time.

For the purpose of multi-cast, the ACK transmissions (associated with the same data packet) of the individual devices are allowed to take place in a sequence.

- 5) The energy detection threshold for the CCA shall be proportional to the transmit power of the transmitter: for a 20 dBm e.i.r.p. transmitter the CCA threshold level (TL) shall be equal to or less than -70 dBm/MHz at the input to the receiver assuming a 0 dBi (receive) antenna assembly. This threshold level (TL) may be corrected for the (receive) antenna assembly gain (G); however, beamforming gain (Y) shall not be taken into account. For power levels less than 20 dBm e.i.r.p. the CCA threshold level may be relaxed to:

$$TL = -70 \text{ dBm/MHz} + 10 \times \log_{10} (100 \text{ mW} / P_{out}) \quad (P_{out} \text{ in mW e.i.r.p.})$$

- 6) The equipment shall comply with the requirements defined in step 1 to step 4 in the present clause in the presence of an unwanted CW signal as defined in table 10.

Table 10: Unwanted Signal parameters

Wanted signal mean power from companion device	Unwanted signal frequency (MHz)	Unwanted signal power (dBm)
sufficient to maintain the link (see note 2)	2 395 or 2 488,5 (see note 1)	-35 (see note 3)
NOTE 1: The highest frequency shall be used for testing operating channels within the range 2 400 MHz to 2 442 MHz, while the lowest frequency shall be used for testing operating channels within the range 2 442 MHz to 2 483,5 MHz. See clause 5.4.6.1.		
NOTE 2: A typical value which can be used in most cases is -50 dBm/MHz.		
NOTE 3: The level specified is the level in front of the UUT antenna. In case of conducted measurements, this level has to be corrected by the actual antenna assembly gain.		

An example of the timing for Frame Based Equipment is provided in figure 2.

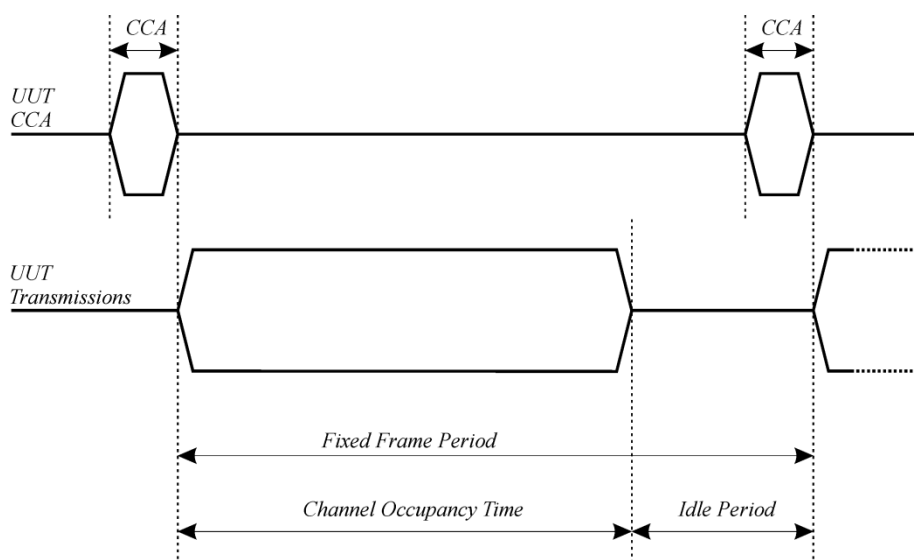

Figure 2: Example of timing for Frame Based Equipment

4.3.2.6.3.2.3 Load Based Equipment

Load Based Equipment may implement an LBT based spectrum sharing mechanism based on the Clear Channel Assessment (CCA) mode using energy detect as described in IEEE 802.11™-2012 [i.3], clause 9, clause 10, clause 16, clause 17, clause 19 and clause 20, or in IEEE 802.15.4™-2011 [i.4], clause 4, clause 5 and clause 8 providing the equipment complies with the conformance requirements referred to in clause 4.3.2.6.3.4. Load Based Equipment not using any of the mechanisms referenced above shall comply with the following minimum set of requirements:

- 1) Before a transmission or a burst of transmissions, the equipment shall perform a Clear Channel Assessment (CCA) check using energy detect. The equipment shall observe the operating channel for the duration of the CCA observation time which shall be not less than 18 μ s. The channel shall be considered occupied if the energy level in the channel exceeds the threshold given in step 5 below. If the equipment finds the channel to be clear, it may transmit immediately.
- 2) If the equipment finds the channel occupied, it shall not transmit on this channel (see also the next paragraph). The equipment shall perform an Extended CCA check in which the channel is observed for a random duration in the range between 18 μ s and at least 160 μ s. If the extended CCA check has determined the channel to be no longer occupied, the equipment may resume transmissions on this channel. If the Extended CCA time has determined the channel still to be occupied, it shall perform new Extended CCA checks until the channel is no longer occupied.

NOTE: The Idle Period in between transmissions is considered to be the CCA or the Extended CCA check as there are no transmissions during this period.

The equipment is allowed to switch to a non-adaptive mode and to continue transmissions on this channel providing it complies with the requirements applicable to non-adaptive equipment. Alternatively, the equipment is also allowed to continue Short Control Signalling Transmissions on this channel providing it complies with the requirements given in clause 4.3.2.6.4.

- 3) The total time that an equipment makes use of a RF channel is defined as the Channel Occupancy Time. This Channel Occupancy Time shall be less than 13 ms, after which the device shall perform a new CCA as described in step 1 above.
- 4) The equipment, upon correct reception of a packet which was intended for this equipment can skip CCA and immediately (see also next paragraph) proceed with the transmission of management and control frames (e.g. ACK and Block ACK frames are allowed but data frames are not allowed). A consecutive sequence of transmissions by the equipment without a new CCA shall not exceed the maximum channel occupancy time as defined in step 3 above.

For the purpose of multi-cast, the ACK transmissions (associated with the same data packet) of the individual devices are allowed to take place in a sequence.

- 5) The energy detection threshold for the CCA shall be proportional to the transmit power of the transmitter: for a 20 dBm e.i.r.p. transmitter the CCA threshold level (TL) shall be equal to or less than -70 dBm/MHz at the input to the receiver assuming a 0 dBi (receive) antenna assembly. This threshold level (TL) may be corrected for the (receive) antenna assembly gain (G); however, beamforming gain (Y) shall not be taken into account. For power levels less than 20 dBm e.i.r.p., the CCA threshold level may be relaxed to:

$$TL = -70 \text{ dBm/MHz} + 10 \times \log_{10} (100 \text{ mW} / P_{out}) \quad (P_{out} \text{ in mW e.i.r.p.})$$

- 6) The equipment shall comply with the requirements defined in step 1 to step 4 of the present clause in the presence of an unwanted CW signal as defined in table 11.

Table 11: Unwanted Signal parameters

Wanted signal mean power from companion device	Unwanted signal frequency (MHz)	Unwanted signal power (dBm)
sufficient to maintain the link (see note 2)	2 395 or 2 488,5 (see note 1)	-35 (see note 3)
NOTE 1: The highest frequency shall be used for testing operating channels within the range 2 400 MHz to 2 442 MHz, while the lowest frequency shall be used for testing operating channels within the range 2 442 MHz to 2 483,5 MHz. See clause 5.4.6.1. NOTE 2: A typical value which can be used in most cases is -50 dBm/MHz. NOTE 3: The level specified is the level in front of the UUT antenna. In case of conducted measurements, this level has to be corrected by the actual antenna assembly gain.		

4.3.2.6.3.4 Conformance

The conformance tests for this requirement are defined in clause 5.4.6 and specifically in clause 5.4.6.2.1.4.

4.3.2.6.4 Short Control Signalling Transmissions

4.3.2.6.4.1 Definition

Short Control Signalling Transmissions are transmissions used by adaptive equipment to send control signals (e.g. ACK/NACK signals, etc.) without sensing the operating channel for the presence of other signals.

Adaptive equipment may or may not have Short Control Signalling Transmissions.

4.3.2.6.4.2 Limits

If implemented, Short Control Signalling Transmissions of adaptive equipment using wide band modulations other than FHSS shall have a maximum TxOn / (TxOn + TxOff) ratio of 10 % within any observation period of 50 ms.

NOTE: Duty Cycle is defined in clause 4.3.2.4.2.

4.3.2.6.4.3 Conformance

The conformance tests for this requirement are defined in clause 5.4.6.2.1.3 (for non-LBT based adaptive equipment using modulations other than FHSS) or clause 5.4.6.2.1.4 (for LBT based adaptive equipment using modulations other than FHSS).

4.3.2.7 Occupied Channel Bandwidth

4.3.2.7.1 Applicability

This requirement applies to all types of equipment using wide band modulations other than FHSS.

4.3.2.7.2 Definition

The Occupied Channel Bandwidth is the bandwidth that contains 99 % of the power of the signal.

4.3.2.7.3 Limits

The Occupied Channel Bandwidth shall fall completely within the band given in table 1.

In addition, for non-adaptive equipment using wide band modulations other than FHSS and with e.i.r.p. greater than 10 dBm, the occupied channel bandwidth shall be less than 20 MHz.

4.3.2.7.4 Conformance

The conformance tests for this requirement are defined in clause 5.4.7.

4.3.2.8 Transmitter unwanted emissions in the out-of-band domain

4.3.2.8.1 Applicability

This requirement applies to all types of equipment using wide band modulations other than FHSS.

4.3.2.8.2 Definition

Transmitter unwanted emissions in the out-of-band domain are emissions when the equipment is in Transmit mode, on frequencies immediately outside the necessary bandwidth which results from the modulation process, but excluding spurious emissions.

4.3.2.8.3 Limit

The transmitter unwanted emissions in the out-of-band domain but outside the allocated band, shall not exceed the values provided by the mask in figure 3.

Within the band specified in table 1, the Out-of-band emissions are fulfilled by compliance with the Occupied Channel Bandwidth requirement in clause 4.3.2.7.

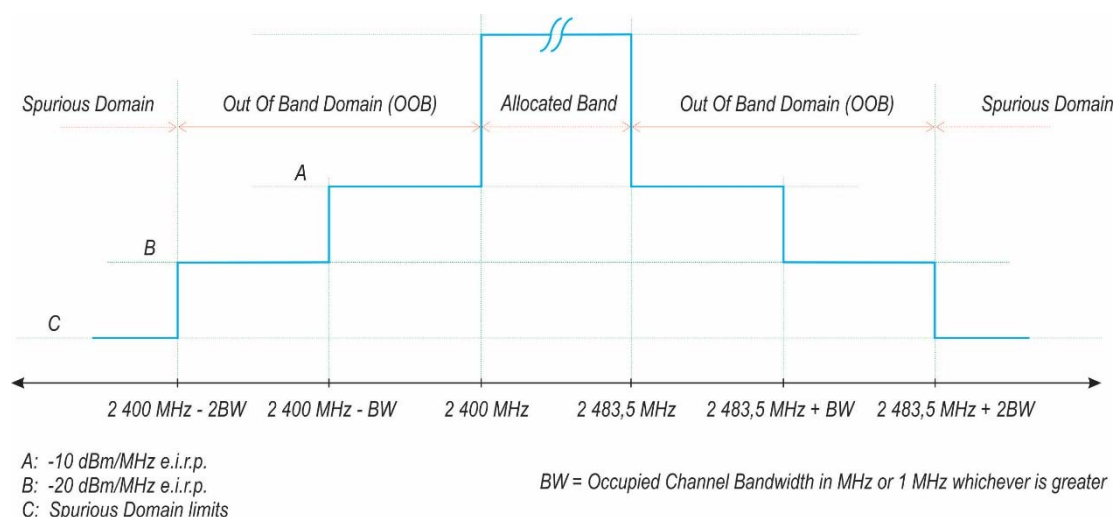

Figure 3: Transmit mask

4.3.2.8.4 Conformance

The conformance tests for this requirement are defined in clause 5.4.8.

4.3.2.9 Transmitter unwanted emissions in the spurious domain

4.3.2.9.1 Applicability

This requirement applies to all types of equipment using wide band modulations other than FHSS.

4.3.2.9.2 Definition

Transmitter unwanted emissions in the spurious domain are emissions outside the allocated band and outside the Out-of-band Domain as indicated in figure 3 when the equipment is in Transmit mode.

4.3.2.9.3 Limit

The transmitter unwanted emissions in the spurious domain shall not exceed the values given in table 12.

In case of equipment with antenna connectors, these limits apply to emissions at the antenna port (conducted). For emissions radiated by the cabinet or emissions radiated by integral antenna equipment (without antenna connectors), these limits are e.r.p. for emissions up to 1 GHz and as e.i.r.p. for emissions above 1 GHz.

Table 12: Transmitter limits for spurious emissions

Frequency range	Maximum power	Bandwidth
30 MHz to 47 MHz	-36 dBm	100 kHz
47 MHz to 74 MHz	-54 dBm	100 kHz
74 MHz to 87,5 MHz	-36 dBm	100 kHz
87,5 MHz to 118 MHz	-54 dBm	100 kHz
118 MHz to 174 MHz	-36 dBm	100 kHz
174 MHz to 230 MHz	-54 dBm	100 kHz
230 MHz to 470 MHz	-36 dBm	100 kHz
470 MHz to 862 MHz	-54 dBm	100 kHz
862 MHz to 1 GHz	-36 dBm	100 kHz
1 GHz to 12,75 GHz	-30 dBm	1 MHz

4.3.2.9.4 Conformance

The conformance tests for this requirement are defined in clause 5.4.9.

4.3.2.10 Receiver spurious emissions

4.3.2.10.1 Applicability

This requirement applies to all types of equipment using wide band modulations other than FHSS.

4.3.2.10.2 Definition

Receiver spurious emissions are emissions at any frequency when the equipment is in receive mode.

4.3.2.10.3 Limit

The spurious emissions of the receiver shall not exceed the values given in table 13.

In case of equipment with antenna connectors, these limits apply to emissions at the antenna port (conducted). For emissions radiated by the cabinet or for emissions radiated by integral antenna equipment (without antenna connectors), these limits are e.r.p. for emissions up to 1 GHz and e.i.r.p. for emissions above 1 GHz.

Table 13: Spurious emission limits for receivers

Frequency range	Maximum power	Bandwidth
30 MHz to 1 GHz	-57 dBm	100 kHz
1 GHz to 12,75 GHz	-47 dBm	1 MHz

4.3.2.10.4 Conformance

The conformance tests for this requirement are defined in clause 5.4.10.

4.3.2.11 Receiver Blocking

4.3.2.11.1 Applicability

This requirement applies to all receiver categories as defined in clause 4.2.3.

4.3.2.11.2 Definition

Receiver blocking is a measure of the ability of the equipment to receive a wanted signal on its operating channel without exceeding a given degradation in the presence of an unwanted signal (blocking signal) at frequencies other than those of the operating band.

4.3.2.11.3 Performance Criteria

The minimum performance criterion shall be a PER less than or equal to 10 %. The manufacturer may declare alternative performance criteria as long as that is appropriate for the intended use of the equipment (see clause 5.4.1.t)).

4.3.2.11.4 Limits

4.3.2.11.4.1 General

While maintaining the minimum performance criteria as defined in clause 4.3.2.11.3, the blocking levels at specified frequency offsets shall be equal to or greater than the limits defined for the applicable receiver category provided in table 14, table 15 or table 16.

4.3.2.11.4.2 Receiver Category 1

Table 14 contains the Receiver Blocking parameters for Receiver Category 1 equipment.

Table 14: Receiver Blocking parameters for Receiver Category 1 equipment

Wanted signal mean power from companion device (dBm)	Blocking signal frequency (MHz)	Blocking signal power (dBm) (see note 2)	Type of blocking signal
$P_{\min} + 6$ dB	2 380 2 503,5	-53	CW
$P_{\min} + 6$ dB	2 300 2 330 2 360	-47	CW
$P_{\min} + 6$ dB	2 523,5 2 553,5 2 583,5 2 613,5 2 643,5 2 673,5	-47	CW
NOTE 1: P_{\min} is the minimum level of the wanted signal (in dBm) required to meet the minimum performance criteria as defined in clause 4.3.2.11.3 in the absence of any blocking signal.			
NOTE 2: The levels specified are levels in front of the UUT antenna. In case of conducted measurements, the levels have to be corrected by the actual antenna assembly gain.			

4.3.2.11.4.3 Receiver Category 2

Table 15 contains the Receiver Blocking parameters for Receiver Category 2 equipment.

Table 15: Receiver Blocking parameters receiver category 2 equipment

Wanted signal mean power from companion device (dBm)	Blocking signal frequency (MHz)	Blocking signal power (dBm) (see note 2)	Type of blocking signal
$P_{\min} + 6$ dB	2 380 2 503,5	-57	CW
$P_{\min} + 6$ dB	2 300 2 583,5	-47	CW
NOTE 1: P_{\min} is the minimum level of the wanted signal (in dBm) required to meet the minimum performance criteria as defined in clause 4.3.2.11.3 in the absence of any blocking signal.			
NOTE 2: The levels specified are levels in front of the UUT antenna. In case of conducted measurements, the levels have to be corrected by the actual antenna assembly gain.			

4.3.2.11.4.4 Receiver Category 3

Table 16 contains the Receiver Blocking parameters for Receiver Category 3 equipment.

Table 16: Receiver Blocking parameters receiver category 3 equipment

Wanted signal mean power from companion device (dBm)	Blocking signal frequency (MHz)	Blocking signal power (dBm) (see note 2)	Type of blocking signal
$P_{\min} + 12$ dB	2 380 2 503,5	-57	CW
$P_{\min} + 12$ dB	2 300 2 583,5	-47	CW
NOTE 1: P_{\min} is the minimum level of the wanted signal (in dBm) required to meet the minimum performance criteria as defined in clause 4.3.2.11.3 in the absence of any blocking signal.			
NOTE 2: The levels specified are levels in front of the UUT antenna. In case of conducted measurements, the levels have to be corrected by the actual antenna assembly gain.			

4.3.2.11.5 Conformance

The conformance tests for this requirement are defined in clause 5.4.11.

4.3.2.12 Geo-location capability

4.3.2.12.1 Applicability

This requirement only applies to equipment with geo-location capability as defined in clause 4.3.2.12.2.

4.3.2.12.2 Definition

Geo-location capability is a feature of the equipment to determine its geographical location with the purpose to configure itself according to the regulatory requirements applicable at the geographical location where it operates.

The geo-location capability may be present in the equipment or in an external device (temporary) associated with the equipment operating at the same geographical location during the initial power up of the equipment. The geographical location may also be available in equipment already installed and operating at the same geographical location.

4.3.2.12.3 Requirements

The geographical location determined by the equipment as defined in clause 4.3.2.12.2 shall not be accessible to the user.

5 Testing for compliance with technical requirements

5.1 Environmental conditions for testing

5.1.1 Introduction

Tests defined in the present document shall be carried out at representative points within the boundary limits of the declared operational environmental profile.

Where technical performance varies subject to environmental conditions, tests shall be carried out under a sufficient variety of environmental conditions (within the boundary limits of the declared operational environmental profile) to give confidence of compliance for the affected technical requirements.

For each test defined in the present document, the environmental condition(s) at which the test has to be performed is specified in the clause on test conditions for that particular test.

5.1.2 Normal test conditions

5.1.2.1 Normal temperature and humidity

Unless otherwise declared by the manufacturer, the normal temperature and humidity conditions for tests shall be any convenient combination of temperature and humidity within the following ranges:

- temperature: +15 °C to +35 °C;
- relative humidity: 20 % to 75 %.

The actual values during the tests shall be recorded.

5.1.2.2 Normal power source

The normal test voltage for the equipment shall be the nominal voltage for which the equipment was designed.

5.1.3 Extreme test conditions

Some tests in the present document need to be repeated at extreme temperatures. Where that is the case, measurements shall be made over the extremes of the operating temperature range as declared by the manufacturer.

5.2 Interpretation of the measurement results

The interpretation of the results recorded in a test report for the measurements described in the present document shall be as follows:

- the measured value related to the corresponding limit will be used to decide whether an equipment meets the requirements of the present document;
- the value of the measurement uncertainty for the measurement of each parameter shall be included in the test report;
- the recorded value of the measurement uncertainty shall be, for each measurement, equal to or less than the figures in table 17.

For the test methods, according to the present document, the measurement uncertainty figures shall be calculated and shall correspond to an expansion factor (coverage factor) $k = 1,96$ or $k = 2$ (which provide confidence levels of respectively 95 % and 95,45 % in the case where the distributions characterizing the actual measurement uncertainties are normal (Gaussian)). Principles for the calculation of measurement uncertainty are contained in ETSI TR 100 028-1 [i.15], in particular in annex D of the ETSI TR 100 028-2 [i.11].

Table 17 is based on such expansion factors.

Table 17: Maximum measurement uncertainty

Parameter	Uncertainty
Occupied Channel Bandwidth	± 5 %
RF output power, conducted	$\pm 1,5$ dB
Power Spectral Density, conducted	± 3 dB
Unwanted Emissions, conducted	± 3 dB
All emissions, radiated	± 6 dB
Temperature	± 3 °C
Supply voltages	± 3 %
Time	± 5 %

5.3 Definition of other test conditions

5.3.1 Test mode

Unless otherwise specified, the measurements shall be performed using normal operation of the equipment with the equipment operating with the worst case configuration (for example modulation, bandwidth, data rate, power) with regards to the requirement to be tested. For each of the requirements in the present document, this worst case configuration shall be declared by the manufacturer (see clause 5.4.1 f) and documented in the test report. Special software may be used to operate the equipment in this mode.

For frequency hopping equipment the equipment should allow specific hop frequencies to be selected manually to facilitate some of the tests to be performed.

5.3.2 Antennas and transmit operating modes

5.3.2.1 Integrated and dedicated antennas

The equipment can have either integral antennas or dedicated antennas. Dedicated antennas are assessed in combination with the equipment against the requirements in the present document.

NOTE: Assessment does not necessarily lead to testing.

An antenna assembly referred to in the present document is understood as the combination of the antenna (integral or dedicated), its feeder (e.g. coaxial cable) and if applicable, its antenna connector and associated switching components. The gain of an antenna assembly (G) in dBi, does not include the additional gain that may result out of beamforming.

Smart antenna systems may use beamforming techniques which may result in additional (antenna) gain. This beamforming gain (Y) is specified in dB. The individual antennas used by smart antenna systems are considered to have identical gain referred to as antenna assembly gain (G). Beamforming gain does not include the gain of the antenna assembly (G).

Although the measurement methods in the present document allow conducted measurements to be performed, it should be noted that the equipment together with all its intended antenna assemblies shall comply with the applicable technical requirements defined in the present document.

5.3.2.2 Smart antenna systems and related operating modes

5.3.2.2.1 Introduction

Smart antenna systems can operate in various operating modes by which the numbers of active chains (antennas) vary depending on the mode.

5.3.2.2.2 Operating mode 1 (single antenna)

The equipment uses only one antenna at any moment in time when operating in this mode.

The following types of equipment and/or operating modes are examples covered by this category:

- Equipment with only one antenna.
- Equipment with two diversity antennas operating in switched diversity mode by which at any moment in time only one antenna is used.
- Smart antenna system with two or more transmit/receive chains, but operating in a mode where only one transmit/receive chain is used.

5.3.2.2.3 Operating mode 2 (multiple antennas, no beamforming)

The equipment that can operate in this mode contains a smart antenna system using two or more transmit/receive chains simultaneously but without beamforming.

5.3.2.2.4 Operating mode 3 (multiple antennas, with beamforming)

The equipment that can operate in this mode contains a smart antenna system using two or more transmit/receive chains simultaneously with beamforming.

In addition to the antenna assembly gain (G), the beamforming gain (Y) may have to be taken into account when performing the measurements described in the present document.

5.3.2.3 Configuration for testing

Unless otherwise stated, where multiple combinations of radio equipment and antennas are intended, the configuration to be used for testing shall be chosen as follows:

- for each combination, determine the highest user selectable power level and the antenna assembly with the highest gain;
- from the resulting combinations, choose the one with the highest e.i.r.p.

5.3.3 Adaptive and Non-adaptive equipment

Equipment which can operate in both a non-adaptive and an adaptive mode (see clause 4.2.2) shall be tested in both modes. Equipment which can operate in more than one adaptive mode, shall be tested in each of these adaptive modes.

5.3.4 Presentation of equipment

5.3.4.1 Introduction

Equipment submitted for testing is presented as either stand-alone equipment, plug-in radio equipment or combined equipment.

5.3.4.2 Testing of stand-alone equipment

Stand-alone equipment shall be tested against the requirements of the present document.

5.3.4.3 Testing of host connected equipment and plug-in radio equipment

5.3.4.3.1 Introduction

For combined equipment and for radio parts for which connection to or integration with host equipment is required to offer functionality to the radio, different alternative test approaches are permitted. Where more than one such combination is intended, testing shall not be repeated for combinations of the radio part and various host equipment where the latter are substantially similar.

Where more than one such combination is intended and the combinations are not substantially similar, one combination shall be tested against all requirements of the present document and all other combinations shall be tested separately for radiated spurious emissions only.

5.3.4.3.2 The use of a host or test jig for testing plug-in radio equipment

Where the radio part is a plug-in radio equipment which is intended to be used within a variety of combinations, a suitable test configuration consisting of either a test jig or a typical host equipment shall be used. This shall be representative for the range of combinations in which the equipment may be used. The test jig shall allow the radio equipment part to be powered and stimulated as if connected to or inserted into host or combined equipment. Measurements shall be made to all requirements of the present document.

5.3.4.3.3 Testing of combinations

5.3.4.3.3.1 Alternative A: General approach for combinations

Combined equipment or a combination of a plug-in radio equipment and a specific type of host equipment may be used for testing according to the full requirements of the present document.

5.3.4.3.3.2 Alternative B: For host equipment with a plug-in radio equipment

A combination of a plug-in radio equipment and a specific type of host equipment may be used for testing according to the full requirements of the present document.

For radiated emission tests the most appropriate standard shall be applied to the host equipment. The plug-in radio equipment shall meet the radiated emissions requirements as described in the present document.

5.3.4.3.3.3 Alternative C: For combined equipment with a plug-in radio equipment

Combined equipment may be used for testing according to the full requirements of the present document.

For radiated emissions the requirements of the most appropriate harmonised EMC standard shall be applied to the non-radio equipment. The plug-in radio equipment shall meet the radiated emissions requirements as described in the present document. In the case where the plug-in radio equipment is totally integrated and cannot operate independently, radiated emissions for the combination shall be tested using the most appropriate harmonised standard with the radio part in receive and/or standby mode. If the frequency range is less than the one defined in the present document, additional measurements shall be performed to cover the remaining parts of the frequency range. With the radio in transmit mode, the radiated emissions requirements of the present document shall be applied.

5.3.4.3.3.4 Alternative D: For equipment with multiple radios

5.3.4.3.3.4.1 Introduction

Multi-radio equipment, where at least one of the radio parts is within the scope of the present document, may be used for testing according to the full requirements of the present document. Additional requirements and limits for multi-radio equipment are set out in the relevant harmonised radio product standards applicable to the other radio parts.

When measuring spurious emissions in the receive and/or standby mode, it is essential that none of the transmitters within the combined equipment are transmitting.

5.3.4.3.3.4.2 The spurious emissions from each radio can be identified

Where the spurious emissions from each radio can be identified, then the spurious emissions from each radio are assessed to the relevant harmonised radio standard.

5.3.4.3.3.4.3 The spurious emissions from each radio cannot be identified

Where the spurious emissions from each radio cannot be identified, then the combined equipment is assessed to the spurious emission requirements contained in all of the relevant harmonised radio standards applicable to the radios contained within the combined product.

Where the applicable harmonised radio standards contain different limits and measuring conditions, then the combined product is assessed to the harmonised radio standard that specifies the least stringent limits for the common part of the frequency measurement ranges. To assess the remaining parts of the frequency measurement ranges the limits from the relevant harmonised radio standard should be used.

5.3.5 Conducted measurements, radiated measurements, relative measurements

Unless otherwise specified, either conducted or radiated measurements can be used.

For integral antenna equipment, connectors may be provided to allow conducted measurements to be performed.

In the case of integral antenna equipment that has no antenna connector(s), the manufacturer may be required to supply a test fixture, to allow relative measurements to be made.

The test fixture and its use are further described in clause B.4.

5.4 Test procedures for essential radio test suites

5.4.1 Product Information

The following information shall be stated by the manufacturer in order to carry out the test suites and/or to declare compliance to technical requirements (e.g. technical requirements for which no conformance test is included in the present document). This information shall be included in the test report. The application form in annex E can be used for that.

- a) the type of wide band modulation used: FHSS modulation, or any other type of modulation (see clause 4.2.1);
- b) where FHSS modulation is used: the number of hopping frequencies and the dwell time per channel. For adaptive FHSS equipment, the average dwell time, the maximum number of Hopping Frequencies and the minimum number of Hopping Frequencies;
- c) whether or not the equipment is a non-adaptive equipment, an adaptive equipment or an equipment that can operate in both an adaptive and non-adaptive mode;
- d) for adaptive equipment: whether LBT based DAA or non-LBT based DAA (any other form of DAA) is used (see clause 4.3.1.7 and clause 4.3.2.6) and the maximum Channel Occupancy Time implemented by the equipment; for LBT based adaptive equipment using wide band modulations other than FHSS, whether the equipment is Frame Based Equipment (clause 4.3.2.6.3.2.2) or Load Based Equipment (clause 4.3.2.6.3.2.3);
- e) for non-adaptive equipment, the maximum duty cycle used by the equipment. For equipment with a dynamic behaviour with regard to RF Output Power and Duty Cycle, such behaviour shall be described. (e.g. the different combinations of duty cycle and corresponding power levels shall be declared);
- f) for each of the tests to be performed, the worst case configuration (see clause 5.3.1);
- g) the different transmit operating modes in which the equipment can operate (see clause 5.3.2.2);
- h) for each of the modes declared under g) the following shall be declared:
 - the number of transmit chains;

- if more than one transmit chain is active, whether the power is distributed equally or not;
 - the number of receive chains;
 - whether or not antenna beamforming is implemented, and if so the maximum beamforming gain (Y) or the total antenna gain (G + Y) for this transmit operating mode;
- i) the operating frequency range(s) of the equipment;
 - j) the Nominal Channel Bandwidth(s). For non-adaptive Frequency Hopping equipment, this is the nominal channel bandwidth when operating on a single hopping frequency;
 - k) the type of the equipment, for example: stand-alone equipment, plug-in radio equipment, combined equipment, etc. (see also clause 5.3.4);
 - l) the operational environmental profile (e.g. the normal test conditions and extreme test conditions) that applies to the equipment (see also clause 5.1);
 - m) the intended combination(s) of the radio equipment power settings and one or more antenna assemblies, their corresponding maximum gain(s) (G) and the resulting e.i.r.p. levels taking also into account the beamforming gain (Y) if applicable (see also clause 5.3.2.2.4). For equipment where in receive mode, the antenna assembly gain and/or beamforming gain is different from the transmit mode, the antenna assemblies, their corresponding maximum gain(s) (G) and the beamforming gain (Y) that apply in the receive mode;
 - n) the nominal voltages of the stand-alone radio equipment or the nominal voltages of the host equipment or combined equipment in case of plug-in equipment;
 - o) any specific test modes available which can be used to facilitate testing;
 - p) the equipment type (e.g. Bluetooth[®], IEEE 802.11[™] [i.3], IEEE 802.15.4[™] [i.4], proprietary, etc.);
 - q) for FHSS equipment implementing Option 1 in clause 4.3.1.4.3.1 or Option 1 in clause 4.3.1.4.3.2 (Frequency Occupation requirement), in case compliance cannot be proven via measurements in clause 5.4.4.2.1, step 5 (as the frequency occupation in receive and idle modes cannot be measured), the manufacturer shall provide a statistical analysis to demonstrate compliance with the Frequency Occupation requirement;
 - r) for FHSS equipment implementing Option 2 in clause 4.3.1.4.3.1 or Option 2 in clause 4.3.1.4.3.2 (Frequency Occupation requirement), the manufacturer shall provide a statistical analysis to demonstrate compliance with this requirement;
 - s) whether or not the equipment supports a geo-location capability as defined in clause 4.3.1.13 or clause 4.3.2.12;
 - t) where applicable, the minimum performance criteria (see clause 4.3.1.12.3 or clause 4.3.2.11.3) that corresponds to the intended use of the equipment.

5.4.2 RF output power, Duty Cycle, Tx-sequence, Tx-gap, Medium Utilization

5.4.2.1 Test conditions

See clause 5.1 for the environmental test conditions. Apart from the RF output power, these measurements need only to be performed at normal environmental conditions. The measurements for RF output power shall be performed at both normal environmental conditions and at the extremes of the operating temperature range.

In the case of equipment intended for use with an integral antenna and where no antenna connectors are provided, a test fixture as described in clause B.4 may be used to perform relative measurements at the extremes of the operating temperature range.

The equipment shall be operated under its worst case configuration (for example modulation, bandwidth, data rate. power) with regards to the requirement being tested. Measurement of multiple data sets may be required.

For equipment using FHSS modulation, the measurements shall be performed during normal operation (hopping) and the equipment is assumed to have no blacklisted frequencies (operating on all hopping positions).

For equipment using wide band modulations other than FHSS, the measurement shall be performed at the lowest, the middle, and the highest channel on which the equipment can operate. These frequencies shall be recorded.

5.4.2.2 Test method

5.4.2.2.1 Conducted measurements

5.4.2.2.1.1 Introduction

In case of conducted measurements the transmitter shall be connected to the measuring equipment. The RF power as defined in clause 4.3.1.2 or clause 4.3.2.2 shall be measured and recorded.

5.4.2.2.1.2 RF Output Power

The test procedure shall be as follows:

Step 1:

- Use a fast power sensor suitable for 2,4 GHz and capable of minimum 1 MS/s.
- Use the following settings:
 - Sample speed 1 MS/s or faster.
 - The samples shall represent the RMS power of the signal.
 - Measurement duration: For non-adaptive equipment: equal to the observation period defined in clause 4.3.1.3.2 or clause 4.3.2.4.2. For adaptive equipment, the measurement duration shall be long enough to ensure a minimum number of bursts (at least 10) is captured.

For adaptive equipment, to increase the measurement accuracy, a higher number of bursts may be used.

Step 2:

- For conducted measurements on devices with one transmit chain:
 - Connect the power sensor to the transmit port, sample the transmit signal and store the raw data. Use these stored samples in all following steps.
- For conducted measurements on devices with multiple transmit chains:
 - Connect one power sensor to each transmit port for a synchronous measurement on all transmit ports.
 - Trigger the power sensors so that they start sampling at the same time. Make sure the time difference between the samples of all sensors is less than 500 ns.
 - For each individual sampling point (time domain), sum the coincident power samples of all ports and store them. Use these summed samples as the new stored data set.

Step 3:

- Find the start and stop times of each burst in the stored measurement samples.

The start and stop times are defined as the points where the power is at least 30 dB below the highest value of the stored samples in step 2.

In case of insufficient dynamic range, the value of 30 dB may need to be reduced appropriately.

Step 4:

- Between the start and stop times of each individual burst calculate the RMS power over the burst using the formula below. The start and stop points shall be included. Save these P_{burst} values, as well as the start and stop times for each burst.

$$P_{burst} = \frac{1}{k} \sum_{n=1}^k P_{sample}(n)$$

with k being the total number of samples and n the actual sample number.

Step 5:

- The highest of all P_{burst} values (value A in dBm) will be used for maximum e.i.r.p. calculations.

Step 6:

- Add the (stated) antenna assembly gain G in dBi of the individual antenna.
- If applicable, add the additional beamforming gain Y in dB.
- If more than one antenna assembly is intended for this power setting, the maximum overall antenna gain (G or G + Y) shall be used.
- The RF Output Power (P) shall be calculated using the formula below:

$$P = A + G + Y$$

- This value, which shall comply with the limit given in clause 4.3.1.2.3 or clause 4.3.2.2.3, shall be recorded in the test report.

5.4.2.2.1.3 Duty Cycle, Tx-sequence, Tx-gap

The test procedure, which shall only be performed for non-adaptive equipment, shall be as follows:

Step 1:

- Use the same stored measurement samples from the procedure described in clause 5.4.2.2.1.2.
- The start and stop times are defined as the points where the power is at least 30 dB below the highest value of the stored samples. In case of insufficient dynamic range, the value of 30 dB may need to be reduced appropriately.

Step 2:

- Between the saved start and stop times of each individual burst, calculate the TxOn time. Save these TxOn values.

Step 3:

- Duty Cycle (DC) is the sum of all TxOn times between the end of the first gap (which is the start of the first burst within the observation period) and the start of the last burst (within this observation period) divided by the observation period. The observation period is defined in clause 4.3.1.3.2 or clause 4.3.2.4.2.

Step 4:

- For equipment using blacklisting, the TxOn time measured for a single (and active) hopping frequency shall be multiplied by the number of blacklisted frequencies. This value shall be added to the sum calculated in step 3 above. If the number of blacklisted frequencies cannot be determined, the minimum number of hopping frequencies (N) as defined in clause 4.3.1.4.3 shall be assumed.
- The calculated value for Duty Cycle (DC) shall be recorded in the test report. This value shall be equal to or less than the maximum value declared by the manufacturer.

Step 5:

- Use the same stored measurement samples from the procedure described in clause 5.4.2.2.1.2.
- Identify any TxOff time that is equal to or greater than the minimum Tx-gap time as defined in clause 4.3.1.3.3 or clause 4.3.2.4.3. These are the potential valid gap times to be further considered in this procedure.
- Starting from the second identified gap, calculate the time from the start of this gap to the end of the preceding gap. This time is the Tx-sequence time for this transmission. Repeat this procedure until the last identified gap within the observation period is reached.
- A combination of consecutive Tx-sequence times and Tx-gap times followed by a Tx-gap time, which is at least as long as the duration of this combination, may be considered as a single Tx-sequence time and in which case it shall comply with the limits defined in clause 4.3.1.3.3 or clause 4.3.2.4.3.
- It shall be noted in the test report whether the UUT complies with the limits for the maximum Tx-sequence time and minimum Tx-gap time as defined in clause 4.3.1.3.3 or clause 4.3.2.4.3.

5.4.2.2.1.4 Medium Utilization

The test procedure, which shall only be performed for non-adaptive equipment, shall be as follows:

Step 1:

- Use the same stored measurement samples from the procedure described in clause 5.4.2.2.1.2.

Step 2:

- For each burst calculate the product of ($P_{\text{burst}} / 100 \text{ mW}$) and the TxOn time. P_{burst} is expressed in mW. TxOn time is expressed in ms.

Step 3:

- Medium Utilization is the sum of all these products divided by the observation period (expressed in ms) which is defined in clause 4.3.1.3.2 or clause 4.3.2.4.2. This value, which shall comply with the limit given in clause 4.3.1.6.3 or clause 4.3.2.5.3, shall be recorded in the test report.

If operation without blacklisted frequencies is not possible, the power of the bursts on blacklisted hopping frequencies (for the calculation of the Medium Utilization) is assumed to be equal to the average value of the RMS power of the bursts on all active hopping frequencies.

5.4.2.2.2 Radiated measurements

When performing radiated measurements, the UUT shall be configured and antenna(s) positioned (including smart antenna systems and equipment capable of beamforming) for maximum e.i.r.p. towards the measuring antenna. This position shall be recorded.

A test site as described in annex B and applicable measurement procedures as described in annex C shall be used.

Taking into account the calibration factor from the measurement site, the test procedure for RF Output Power is further as described under clause 5.4.2.2.1.2, step 1 to step 5. The RF Output Power P is equal to the value A obtained in step 5. The test procedure for Duty Cycle, Tx-sequence, Tx-gap is further as described in clause 5.4.2.2.1.3 and the test procedure for Medium Utilization is further as described in clause 5.4.2.2.1.4.

5.4.3 Power Spectral Density**5.4.3.1 Test conditions**

See clause 5.1 for the environmental test conditions. These measurements shall only be performed at normal test conditions.

The measurement shall be repeated for the equipment being configured to operate at the lowest, the middle, and the highest frequency of the stated frequency range. These frequencies shall be recorded.

For the duration of the test, the equipment shall not change its operating frequency.

5.4.3.2 Test method

5.4.3.2.1 Conducted measurement

Option 1: For equipment with continuous and non-continuous transmissions

The transmitter shall be connected to a spectrum analyser and the Power Spectral Density (PSD) as defined in clause 4.3.2.3 shall be measured and recorded.

The test procedure shall be as follows:

Step 1:

Connect the UUT to the spectrum analyser and use the following settings:

- Start Frequency: 2 400 MHz
- Stop Frequency: 2 483,5 MHz
- Resolution BW: 10 kHz
- Video BW: 30 kHz
- Sweep Points: > 8 350; for spectrum analysers not supporting this number of sweep points, the frequency band may be segmented
- Detector: RMS
- Trace Mode: Max Hold
- Sweep time: For non-continuous transmissions: $2 \times \text{Channel Occupancy Time} \times \text{number of sweep points}$
For continuous transmissions: 10 s; the sweep time may be increased further until a value where the sweep time has no further impact anymore on the RMS value of the signal.

For non-continuous signals, wait for the trace to stabilize.

Save the data (trace data) set to a file.

Step 2:

For conducted measurements on smart antenna systems using either operating mode 2 or operating mode 3 (see clause 5.3.2.2), repeat the measurement for each of the transmit ports. For each sampling point (frequency domain), add up the coincident power values (in mW) for the different transmit chains and use this as the new data set.

Step 3:

Add up the values for power for all the samples in the file using the formula below.

$$P_{Sum} = \sum_{n=1}^k P_{sample}(n)$$

with k being the total number of samples and n the actual sample number

Step 4:

Normalize the individual values for power (in dBm) so that the sum is equal to the RF Output Power (e.i.r.p.) measured in clause 5.4.2 and save the corrected data. The following formulas can be used:

$$C_{Corr} = P_{Sum} - P_{e.i.r.p.}$$

$$P_{Samplecorr}(n) = P_{Sample}(n) - C_{Corr}$$

with n being the actual sample number

Step 5:

Starting from the first sample $P_{Samplecorr}(n)$ (lowest frequency), add up the power (in mW) of the following samples representing a 1 MHz segment and record the results for power and position (i.e. sample #1 to sample #100). This is the Power Spectral Density (e.i.r.p.) for the first 1 MHz segment which shall be recorded.

Step 6:

Shift the start point of the samples added up in step 5 by one sample and repeat the procedure in step 5 (i.e. sample #2 to sample #101).

Step 7:

Repeat step 6 until the end of the data set and record the Power Spectral Density values for each of the 1 MHz segments.

From all the recorded results, the highest value is the maximum Power Spectral Density (PSD) for the UUT. This value, which shall comply with the limit given in clause 4.3.2.3.3, shall be recorded in the test report.

Option 2: For equipment with continuous transmission capability or for equipment operating (or with the capability to operate) with a constant duty cycle (e.g. Frame Based equipment)

This option is for equipment that can be configured to operate in a continuous transmit mode (100 % DC) or with a constant Duty Cycle (DC).

Step 1:

- Connect the UUT to the spectrum analyser and use the following settings:
 - Centre Frequency: The centre frequency of the channel under test
 - RBW: 1 MHz
 - VBW: 3 MHz
 - Frequency Span: $2 \times$ Nominal Bandwidth (e.g. 40 MHz for a 20 MHz channel)
 - Detector Mode: Peak
 - Trace Mode: Max Hold

Step 2:

- When the trace is complete, find the peak value of the power envelope and record the frequency.

Step 3:

- Make the following changes to the settings of the spectrum analyser:
 - Centre Frequency: Equal to the frequency recorded in step 2
 - Frequency Span: 3 MHz
 - RBW: 1 MHz
 - VBW: 3 MHz
 - Sweep Time: 1 minute
 - Detector Mode: RMS
 - Trace Mode: Max Hold

Step 4:

- When the trace is complete, the trace shall be captured using the "Hold" or "View" option on the spectrum analyser.
- Find the peak value of the trace and place the analyser marker on this peak. This level is recorded as the highest mean power (power spectral density) D in a 1 MHz band.
- Alternatively, where a spectrum analyser is equipped with a function to measure power spectral density, this function may be used to display the power spectral density D in dBm / MHz.
- In case of conducted measurements on smart antenna systems operating in a mode with multiple transmit chains active simultaneously, the power spectral density of each transmit chain shall be measured separately to calculate the total power spectral density (value D in dBm / MHz) for the UUT.

Step 5:

- The maximum Power Spectral Density (PSD) e.i.r.p. is calculated from the above measured power spectral density D , the observed Duty Cycle (DC) (see clause 5.4.2.2.1.3, step 4), the applicable antenna assembly gain G in dBi and if applicable the beamforming gain Y in dB, according to the formula below. This value shall be recorded in the test report. If more than one antenna assembly is intended for this power setting, the gain of the antenna assembly with the highest gain shall be used.

$$\text{PSD} = D + G + Y + 10 \times \log (1 / \text{DC}) \text{ (dBm / MHz)}$$

5.4.3.2.2 Radiated measurement

When performing radiated measurements, the UUT shall be configured and antenna(s) positioned (including smart antenna systems and equipment capable of beamforming) for maximum e.i.r.p. towards the measuring antenna.

A test site as described in annex B and applicable measurement procedures as described in annex C shall be used.

Taking into account the calibration factor from the measurement site, the test procedure is further as described under clause 5.4.3.2.1.

5.4.4 Accumulated Transmit Time, Frequency Occupation and Hopping Sequence**5.4.4.1 Test conditions**

See clause 5.1 for the environmental test conditions. These measurements shall only be performed at normal test conditions.

The equipment shall be configured to operate at its maximum Dwell Time and maximum Duty Cycle.

The measurement shall be performed on a minimum of two (active) hopping frequencies chosen arbitrary from the actual hopping sequence. The results as well as the frequencies on which the test was performed shall be recorded in the test report.

5.4.4.2 Test method**5.4.4.2.1 Conducted measurements**

The test procedure shall be as follows:

Step 1:

- The output of the transmitter shall be connected to a spectrum analyser or equivalent.
- The analyser shall be set as follows:
 - Centre Frequency: Equal to the hopping frequency being investigated

- Frequency Span: 0 Hz
- RBW: ~ 50 % of the Occupied Channel Bandwidth
- VBW: \geq RBW
- Detector Mode: RMS
- Sweep time: Equal to the applicable observation period (see clause 4.3.1.4.3.1 or clause 4.3.1.4.3.2)
- Number of sweep points: 30 000
- Trace mode: Clear / Write
- Trigger: Free Run

Step 2:

- Save the trace data to a file for further analysis by a computing device using an appropriate software application or program.

Step 3:

- Identify the data points related to the frequency being investigated by applying a threshold.

The data points resulting from transmissions on the hopping frequency being investigated are assumed to have much higher levels compared to data points resulting from transmissions on adjacent hopping frequencies. If a clear determination between these transmissions is not possible, the RBW in step 1 shall be further reduced. In addition, a channel filter may be used.

- Count the number of data points identified as resulting from transmissions on the frequency being investigated and multiply this number by the time difference between two consecutive data points.

Step 4:

- The result in step 3 is the Accumulated Transmit Time which shall comply with the limit provided in clause 4.3.1.4.3.1 or clause 4.3.1.4.3.2 and which shall be recorded in the test report.

Step 5:

This step is only applicable for equipment implementing Option 1 in clause 4.3.1.4.3.1 or Option 1 in clause 4.3.1.4.3.2 for complying with the Frequency Occupation requirement and the manufacturer decides to demonstrate compliance with this requirement via measurement.

- Make the following changes on the analyser and repeat step 2 and step 3.

Sweep time: $4 \times \text{Dwell Time} \times \text{Actual number of hopping frequencies in use}$.

The hopping frequencies occupied by the equipment without having transmissions during the dwell time (blacklisted frequencies) should be taken into account in the actual number of hopping frequencies in use. If this number cannot be determined (number of blacklisted frequencies unknown) it shall be assumed that the equipment uses the maximum possible number of hopping frequencies.

- The result shall be compared to the limit for the Frequency Occupation defined in clause 4.3.1.4.3.1, Option 1 or clause 4.3.1.4.3.2, Option 1. The result of this comparison shall be recorded in the test report.

Step 6:

- Make the following changes on the analyser:

- Start Frequency: 2 400 MHz
- Stop Frequency: 2 483,5 MHz
- RBW: ~ 50 % of the Occupied Channel Bandwidth (single hopping frequency)

- VBW: \geq RBW
 - Detector Mode: RMS
 - Sweep time: 1 s; this setting may result in long measuring times. To avoid such long measuring times, an FFT analyser may be used
 - Trace Mode: Max Hold
 - Trigger: Free Run
- Wait for the trace to stabilize. Identify the number of hopping frequencies used by the hopping sequence.
 - The result shall be compared to the limit (value N) defined in clause 4.3.1.4.3.1 or clause 4.3.1.4.3.2. This value shall be recorded in the test report.

For equipment with blacklisted frequencies, it might not be possible to verify the number of hopping frequencies in use. However, they shall comply with the requirement for Accumulated Transmit Time and Frequency Occupation assuming the minimum number of hopping frequencies (N) defined in clause 4.3.1.4.3.1 or clause 4.3.1.4.3.2 is used.

Step 7:

- For adaptive frequency hopping equipment, it shall be verified whether the equipment uses 70 % of the band specified in table 1. This verification can be done using the lowest and highest -20 dB points from the total spectrum envelope obtained in step 6. The result shall be recorded in the test report.

5.4.4.2.2 Radiated measurements

A test site as described in annex B and applicable measurement procedures as described in annex C may be used. Alternatively, a test fixture may be used.

The test procedure is further as described under clause 5.4.4.2.1.

5.4.5 Hopping Frequency Separation

5.4.5.1 Test conditions

See clause 5.1 for the environmental test conditions. These measurements shall only be performed at normal test conditions.

The measurement shall be performed on two adjacent hopping frequencies. The frequencies on which the test was performed shall be recorded.

5.4.5.2 Test method

5.4.5.2.1 Conducted measurements

5.4.5.2.1.1 Introduction

The Hopping Frequency Separation as defined in clause 4.3.1.5 shall be measured and recorded using any of the following options. The selected option shall be stated in the test report.

5.4.5.2.1.2 Option 1

The test procedure shall be as follows:

Step 1:

- The output of the transmitter shall be connected to a spectrum analyser or equivalent.

- The analyser shall be set as follows:
 - Centre Frequency: Centre of the two adjacent hopping frequencies
 - Frequency Span: Sufficient to see the complete power envelope of both hopping frequencies
 - RBW: 1 % of the span
 - VBW: $3 \times \text{RBW}$
 - Detector Mode: Max Peak
 - Trace Mode: Max Hold
 - Sweep time: Auto

Step 2:

- Wait for the trace to stabilize.
- Use the marker function of the analyser to define the frequencies corresponding to the lower -20 dB_r point and the upper -20 dB_r point for both hopping frequencies F1 and F2. This will result in F1_L and F1_H for hopping frequency F1 and in F2_L and F2_H for hopping frequency F2. These values shall be recorded in the report.

Step 3:

- Calculate the centre frequencies F1_C and F2_C for both hopping frequencies using the formulas below. These values shall be recorded in the report.

$$F1_C = \frac{F1_L + F1_H}{2} \quad F2_C = \frac{F2_L + F2_H}{2}$$

- Calculate the Hopping Frequency Separation (F_{HS}) using the formula below. This value shall be recorded in the report.

$$F_{HS} = F2_C - F1_C$$

- Compare the measured Hopping Frequency Separation with the limit defined in clause 4.3.1.5.3. In addition, for non-Adaptive Frequency Hopping equipment, the Hopping Frequency Separation shall be equal to or greater than the Occupied Channel Bandwidth as defined in clause 4.3.1.8 or:

$$F_{HS} \geq \text{Occupied Channel Bandwidth}$$

- See figure 4:

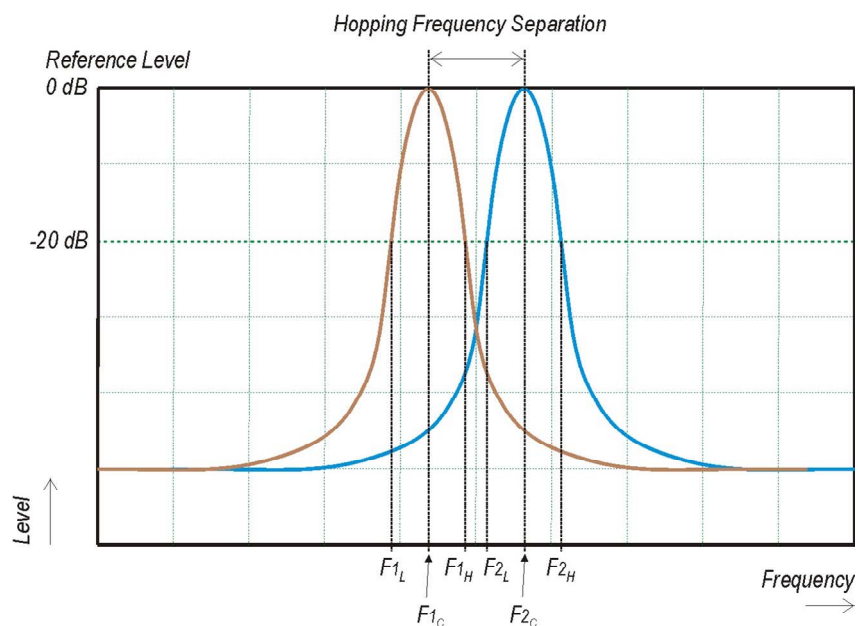

Figure 4: Hopping Frequency Separation

For adaptive equipment, in case of overlapping channels which prevents the definition of the -20 dB reference points $F1_H$ and $F2_L$, a higher reference level (e.g. -10 dB or -6 dB) may be chosen to define the reference points $F1_L$; $F1_H$; $F2_L$ and $F2_H$.

Alternatively, special test software may be used to:

- force the UUT to hop or transmit on a single Hopping Frequency by which the -20 dB reference points can be measured separately for the two adjacent Hopping Frequencies; and/or
- force the UUT to operate without modulation by which the centre frequencies $F1_C$ and $F2_C$ can be measured directly.

The method used to measure the Hopping Frequency Separation shall be documented in the test report.

5.4.5.2.1.3 Option 2

The test procedure shall be as follows:

Step 1:

- The output of the transmitter shall be connected to a spectrum analyser or equivalent.
- The analyser shall be set as follows:
 - Centre Frequency: Centre of the two adjacent hopping frequencies
 - Frequency Span: Sufficient to see the complete power envelope of both hopping frequencies
 - RBW: 1 % of the span
 - VBW: $3 \times$ RBW
 - Detector Mode: Max Peak
 - Trace Mode: Max Hold
 - Sweep Time: Auto

Step 2:

- Wait for the trace to stabilize.
- Use the marker-delta function to determine the Hopping Frequency Separation between the centres of the two adjacent hopping frequencies (e.g. by identifying peaks or notches at the centre of the power envelope for the two adjacent signals). This value shall be compared with the limits defined in clause 4.3.1.5.3 and shall be recorded in the test report.

5.4.5.2.2 Radiated measurements

A test site as described in annex B and applicable measurement procedures as described in annex C may be used. Alternatively a test fixture may be used.

The test procedure is further as described under clause 5.4.5.2.1.

5.4.6 Adaptivity (Channel access mechanism)**5.4.6.1 Test conditions**

See clause 5.1 for the environmental test conditions. These measurements shall only be performed at normal test conditions.

When supported by the operating frequency range of the equipment, this test shall be performed on two operating (hopping) frequencies randomly selected from the operating frequencies used by the equipment. The first (lower) frequency shall be randomly selected within the range 2 400 MHz to 2 442 MHz while the second (higher) frequency shall be randomly selected within the range 2 442 MHz to 2 483,5 MHz. The equipment shall be in a normal operating (hopping) mode.

For equipment which can operate in an adaptive and a non-adaptive mode, it shall be verified that prior to the test, the equipment is operating in the adaptive mode.

The equipment shall be configured in a mode that results in the longest Channel Occupancy Time.

5.4.6.2 Test Method**5.4.6.2.1 Conducted measurements****5.4.6.2.1.1 Test set-up**

Figure 5 describes an example of the test set-up.

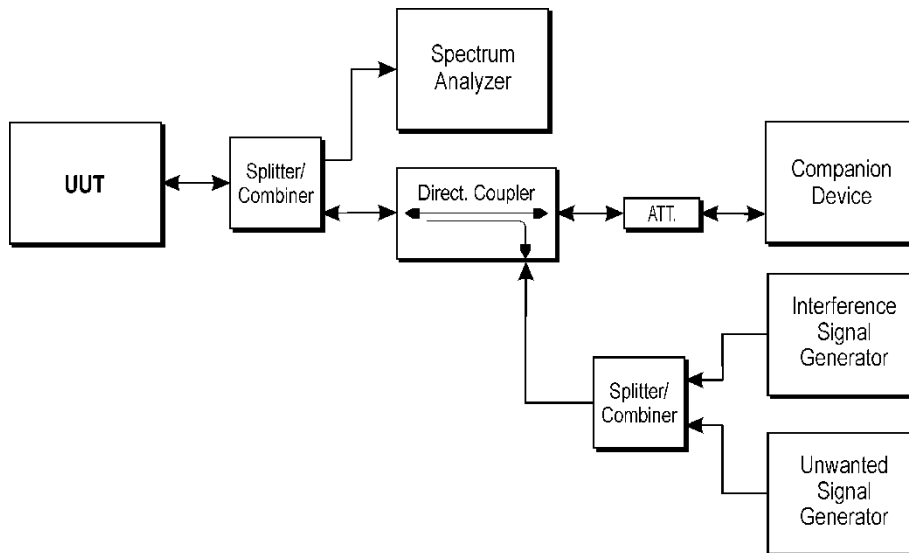

Figure 5: Test set-up for verifying the adaptivity of an equipment

5.4.6.2.1.2 Adaptive Frequency Hopping equipment using DAA

Step 1 to step 7 below define the procedure to verify the efficiency of the DAA based adaptive mechanisms for frequency hopping equipment. These mechanisms are described in clause 4.3.1.7.

For systems using multiple receive chains only one chain (antenna port) need to be tested. All other receiver inputs shall be terminated.

Step 1:

- The UUT shall connect to a companion device during the test. The interference signal generator, the unwanted signal generator, the spectrum analyser, the UUT and the companion device are connected using a set-up equivalent to the example given by figure 5, although the interference and unwanted signal generators do not generate any signals at this point in time. The spectrum analyser is used to monitor the transmissions of both the UUT and the companion device and it should be possible to distinguish between either transmission. In addition, the spectrum analyser is used to monitor the transmissions of the UUT in response to the interfering and the unwanted signals.
- For the hopping frequency to be tested, adjust the received signal level (wanted signal from the companion device) at the UUT to the value defined in table 2 and table 3 (clause 4).

Testing of Unidirectional equipment does not require a link to be established with a companion device.

- The analyser shall be set as follows:
 - RBW: use next available RBW setting below the measured Occupied Channel Bandwidth
 - Filter type: Channel Filter
 - VBW: \geq RBW
 - Detector Mode: RMS
 - Centre Frequency: Equal to the hopping frequency to be tested
 - Span: 0 Hz
 - Sweep time: $>$ Channel Occupancy Time of the UUT. If the Channel Occupancy Time is non-contiguous (non-LBT based equipment), the sweep time shall be sufficient to cover the period over which the Channel Occupancy Time is spread out
 - Trace Mode: Clear/Write
 - Trigger Mode: Video

Step 2:

- Configure the UUT for normal transmissions with a sufficiently high payload resulting in a minimum transmitter activity ratio ($TxOn / (TxOn + TxOff)$) of 0,3. Where this is not possible, the UUT shall be configured to the maximum payload possible.
- Using the procedure defined in clause 5.4.6.2.1.5, it shall be verified that, for equipment with a dwell time greater than the maximum allowable Channel Occupancy Time, the UUT complies with the maximum Channel Occupancy Time and minimum Idle Period defined in clause 4.3.1.7.2.2 or clause 4.3.1.7.3.2. When measuring the Idle Period of the UUT, it shall not include the transmission time of the companion device.

Step 3: Adding the interference signal

- An interference signal as defined in clause B.7 is injected centred on the hopping frequency being tested. The power spectral density level (at the input of the UUT) of this interference signal shall be equal to the detection threshold defined in clause 4.3.1.7.2.2 or clause 4.3.1.7.3.2.

Step 4: Verification of reaction to the interference signal

- The spectrum analyser shall be used to monitor the transmissions of the UUT on the selected hopping frequency with the interfering signal injected. This may require the spectrum analyser sweep to be triggered by the start of the interfering signal.
- Using the procedure defined in clause 5.4.6.2.1.5, it shall be verified that:

- i) The UUT shall stop transmissions on the hopping frequency being tested.

The UUT is assumed to stop transmissions on this hopping frequency within a period equal to the maximum Channel Occupancy Time defined in clause 4.3.1.7.2.2 or clause 4.3.1.7.3.2. As stated in clause 4.3.1.7.3.2, step 3, the Channel Occupancy Time for non-LBT based frequency hopping equipment may be non-contiguous.

- ii) For LBT based frequency hopping equipment, apart from Short Control Signalling Transmissions (see iii) below), there shall be no subsequent transmissions on this hopping frequency, as long as the interference signal remains present.

For non-LBT based frequency hopping equipment, apart from Short Control Signalling Transmissions (see iii) below), there shall be no subsequent transmissions on this hopping frequency for a (silent) period defined in clause 4.3.1.7.3.2, step 2. After that, the UUT may have normal transmissions again for the duration of a single Channel Occupancy Time period (which may be non-contiguous). Because the interference signal is still present, another silent period as defined in clause 4.3.1.7.3.2, step 2 needs to be included. This sequence is repeated as long as the interfering signal is present.

In case of overlapping channels, transmissions in adjacent channels may generate transmission bursts on the channel being investigated; however, they have a lower amplitude as on-channel transmissions. Care should be taken to only evaluate the on-channel transmissions. The Time Domain Power Option of the analyser may be used to measure the RMS power of the individual bursts to distinguish on-channel transmissions from transmissions on adjacent channels. In some cases, the RBW may need to be reduced.

To verify that the UUT is not resuming normal transmissions as long as the interference signal is present, the monitoring time may need to be 60 s or more. If transmissions are detected during this period, the settings of the analyser may need to be adjusted to allow an accurate assessment to verify the transmissions comply with the limits for Short Control Signalling Transmissions.

- iii) The UUT may continue to have Short Control Signalling Transmissions on the hopping frequency being tested while the interference signal is present. These transmissions shall comply with the limits defined in clause 4.3.1.7.4.2.

The verification of the Short Control Signalling transmissions may require the analyser settings to be changed (e.g. sweep time).

- iv) Alternatively, the equipment may switch to a non-adaptive mode.

Step 5: Adding the unwanted signal

- With the interfering signal present, a 100 % duty cycle CW signal is inserted as the unwanted signal. The frequency and the level are provided in table 2 of clause 4.3.1.7.2.2, step 6 or table 3 of clause 4.3.1.7.3.2, step 6.
- The spectrum analyser shall be used to monitor the transmissions of the UUT on the selected hopping frequency. This may require the spectrum analyser sweep to be triggered by the start of the unwanted signal.
- Using the procedure defined in clause 5.4.6.2.1.5, it shall be verified that:
 - i) The UUT shall not resume normal transmissions on the hopping frequency being tested as long as both the interference and unwanted signals remain present.

To verify that the UUT is not resuming normal transmissions as long as the interference and unwanted signals are present, the monitoring time may need to be 60 s or more. If transmissions are detected during this period, the settings of the analyser may need to be adjusted to allow an accurate assessment to verify the transmissions comply with the limits for Short Control Signalling Transmissions.

- ii) The UUT may continue to have Short Control Signalling Transmissions on the hopping frequency being tested while the interference and unwanted signals are present. These transmissions shall comply with the limits defined in clause 4.3.1.7.4.2.

The verification of the Short Control Signalling transmissions may require the analyser settings to be changed (e.g. sweep time).

Step 6: Removing the interference and unwanted signal

- On removal of the interference and unwanted signal, the UUT is allowed to re-include any channel previously marked as unavailable; however, for non-LBT based equipment, it shall be verified that this shall only be done after the period defined in clause 4.3.1.7.3.2, step 2.

Step 7:

- Step 2 to step 6 shall be repeated for each of the hopping frequencies to be tested.

5.4.6.2.1.3 Non-LBT based adaptive equipment using modulations other than FHSS

The different steps below define the procedure to verify the efficiency of the non-LBT based DAA adaptive mechanism of equipment using wide band modulations other than FHSS.

For systems using multiple receive chains only one chain (antenna port) need to be tested. All other receiver inputs shall be terminated.

Step 1:

- The UUT shall connect to a companion device during the test. The interference signal generator, the unwanted signal generator, the spectrum analyser, the UUT and the companion device are connected using a set-up equivalent to the example given by figure 5 although the interference and unwanted signal generator do not generate any signals at this point in time. The spectrum analyser is used to monitor the transmissions of both the UUT and the companion device and it should be possible to distinguish between either transmission. In addition, the spectrum analyser is used to monitor the transmissions of the UUT in response to the interfering and the unwanted signals.
- Adjust the received signal level (wanted signal from the companion device) at the UUT to the value defined in table 9 (clause 4.3.2.6.2.2).

Testing of Unidirectional equipment does not require a link to be established with a companion device.

- The analyser shall be set as follows:
 - RBW: \geq Occupied Channel Bandwidth (if the analyser does not support this setting, the highest available setting shall be used)

- VBW: $3 \times \text{RBW}$ (if the analyser does not support this setting, the highest available setting shall be used)
- Detector Mode: RMS
- Centre Frequency: Equal to the centre frequency of the operating channel
- Span: 0 Hz
- Sweep time: $>$ Channel Occupancy Time of the UUT
- Trace Mode: Clear/Write
- Trigger Mode: Video

Step 2:

- Configure the UUT for normal transmissions with a sufficiently high payload resulting in a minimum transmitter activity ratio ($\text{TxOn} / (\text{TxOn} + \text{TxOff})$) of 0,3. Where this is not possible, the UUT shall be configured to the maximum payload possible.
- Using the procedure defined in clause 5.4.6.2.1.5, it shall be verified that the UUT complies with the maximum Channel Occupancy Time and minimum Idle Period defined in clause 4.3.2.6.2.2. When measuring the Idle Period of the UUT, it shall not include the transmission time of the companion device.

Step 3: Adding the interference signal

- An interference signal as defined in clause B.7 is injected on the current operating channel of the UUT. The power spectral density level (at the input of the UUT) of this interference signal shall be equal to the detection threshold defined in clause 4.3.2.6.2.2, step 5.

Step 4: Verification of reaction to the interference signal

- The spectrum analyser shall be used to monitor the transmissions of the UUT on the selected operating channel with the interfering signal injected. This may require the spectrum analyser sweep to be triggered by the start of the interfering signal.
- Using the procedure defined in clause 5.4.6.2.1.5, it shall be verified that:

- i) The UUT shall stop transmissions on the current operating channel being tested.

The UUT is assumed to stop transmissions within a period equal to the maximum Channel Occupancy Time defined in clause 4.3.2.6.2.2, step 4.

- ii) Apart from Short Control Signalling Transmissions (see iii) below), there shall be no subsequent transmissions on this operating channel for a (silent) period defined in clause 4.3.2.6.2.2, step 2. After that, the UUT may have normal transmissions again for the duration of a single Channel Occupancy Time period. Because the interference signal is still present, another silent period as defined in clause 4.3.2.6.2.2, step 2 needs to be included. This sequence is repeated as long as the interfering signal is present.

To verify that the UUT is not resuming normal transmissions as long as the interference signal is present, the monitoring time may need to be 60 s or more.

- iii) The UUT may continue to have Short Control Signalling Transmissions on the operating channel while the interference signal is present. These transmissions shall comply with the limits defined in clause 4.3.2.6.4.2.

The verification of the Short Control Signalling transmissions may require the analyser settings to be changed (e.g. sweep time).

- iv) Alternatively, the equipment may switch to a non-adaptive mode.

Step 5: Adding the unwanted signal

- With the interfering signal present, a 100 % duty cycle CW signal is inserted as the unwanted signal. The frequency and the level are provided in table 9 of clause 4.3.2.6.2.2.
- The spectrum analyser shall be used to monitor the transmissions of the UUT on the selected operating channel. This may require the spectrum analyser sweep to be triggered by the start of the unwanted signal.
- Using the procedure defined in clause 5.4.6.2.1.5, it shall be verified that:
 - i) The UUT shall not resume normal transmissions on the current operating channel as long as both the interference and unwanted signals remain present.

To verify that the UUT is not resuming normal transmissions as long as the interference and unwanted signals are present, the monitoring time may need to be 60 s or more.
 - ii) The UUT may continue to have Short Control Signalling Transmissions on the operating channel while the interference and unwanted signals are present. These transmissions shall comply with the limits defined in clause 4.3.2.6.4.2.

The verification of the Short Control Signalling transmissions may require the analyser settings to be changed (e.g. sweep time).

Step 6: Removing the interference and unwanted signal

- On removal of the interference and unwanted signal the UUT is allowed to start normal transmissions again on this channel however, it shall be verified that this shall only be done after the period defined in clause 4.3.2.6.2.2, step 2.

Step 7:

- Step 2 to step 6 shall be repeated for each of the frequencies to be tested.

5.4.6.2.1.4 LBT based adaptive equipment using modulations other than FHSS

Step 1 to step 7 below define the procedure to verify the efficiency of the LBT based adaptive mechanism of equipment using wide band modulations other than FHSS. This method can be applied on Load Based Equipment and Frame Based Equipment.

Step 1:

- The UUT shall connect to a companion device during the test. The interference signal generator, the unwanted signal generator, the spectrum analyser, the UUT and the companion device are connected using a set-up equivalent to the example given by figure 5 although the interference and unwanted signal generator do not generate any signals at this point in time. The spectrum analyser is used to monitor the transmissions of both the UUT and the companion device and it should be possible to distinguish between either transmission. In addition, the spectrum analyser is used to monitor the transmissions of the UUT in response to the interfering and the unwanted signals.
- Adjust the received signal level (wanted signal from the companion device) at the UUT to the value defined in table 10 (clause 4.3.2.6.3.2.2) for Frame Based Equipment or in table 11 (clause 4.3.2.6.3.2.3) for Load Based Equipment.

Testing of Unidirectional equipment does not require a link to be established with a companion device.

- The analyser shall be set as follows:
 - RBW: \geq Occupied Channel Bandwidth (if the analyser does not support this setting, the highest available setting shall be used)
 - VBW: $3 \times$ RBW (if the analyser does not support this setting, the highest available setting shall be used)
 - Detector Mode: RMS

- Centre Frequency: Equal to the centre frequency of the operating channel
- Span: 0 Hz
- Sweep time: > maximum Channel Occupancy Time
- Trace Mode: Clear Write
- Trigger Mode: Video

Step 2:

- Configure the UUT for normal transmissions with a sufficiently high payload resulting in a minimum transmitter activity ratio ($TxOn / (TxOn + TxOff)$) of 0,3. Where this is not possible, the UUT shall be configured to the maximum payload possible.
- For Frame Based Equipment, using the procedure defined in clause 5.4.6.2.1.5, it shall be verified that the UUT complies with the maximum Channel Occupancy Time and minimum Idle Period defined in clause 4.3.2.6.3.2.2, step 3. When measuring the Idle Period of the UUT, it shall not include the transmission time of the companion device.
- For Load Based equipment, using the procedure defined in clause 5.4.6.2.1.5, it shall be verified that the UUT complies with the maximum Channel Occupancy Time and minimum Idle Period defined in clause 4.3.2.6.3.2.3, step 2 and step 3. When measuring the Idle Period of the UUT, it shall not include the transmission time of the companion device.

For the purpose of testing Load Based Equipment referred to in the first paragraph of clause 4.3.2.6.3.2.3 (IEEE 802.11™ [i.3] or IEEE 802.15.4™ [i.4] equipment), the limits to be applied for the minimum Idle Period and the maximum Channel Occupancy Time are the same as defined for other types of Load Based Equipment (see clause 4.3.2.6.3.2.3, step 2 and step 3). The Idle Period is considered to be equal to the CCA or Extended CCA time defined in clause 4.3.2.6.3.2.3, step 1 and step 2.

Step 3: Adding the interference signal

- An interference signal as defined in clause B.7 is injected on the current operating channel of the UUT. The power spectral density level (at the input of the UUT) of this interference signal shall be equal to the detection threshold defined in clause 4.3.2.6.3.2.2, step 5 (frame based equipment) or clause 4.3.2.6.3.2.3, step 5 (load based equipment).

Step 4: Verification of reaction to the interference signal

- The spectrum analyser shall be used to monitor the transmissions of the UUT on the selected operating channel with the interfering signal injected. This may require the spectrum analyser sweep to be triggered by the start of the interfering signal.
- Using the procedure defined in clause 5.4.6.2.1.5, it shall be verified that:
 - i) The UUT shall stop transmissions on the current operating channel.

The UUT is assumed to stop transmissions within a period equal to the maximum Channel Occupancy Time defined in clause 4.3.2.6.3.2.2 (frame based equipment) or clause 4.3.2.6.3.2.3 (load based equipment).
 - ii) Apart from Short Control Signalling Transmissions, there shall be no subsequent transmissions while the interfering signal is present.

To verify that the UUT is not resuming normal transmissions as long as the interference signal is present, the monitoring time may need to be 60 s or more.
 - iii) The UUT may continue to have Short Control Signalling Transmissions on the operating channel while the interfering signal is present. These transmissions shall comply with the limits defined in clause 4.3.2.6.4.2.

The verification of the Short Control Signalling transmissions may require the analyser settings to be changed (e.g. sweep time).

iv) Alternatively, the equipment may switch to a non-adaptive mode.

Step 5: Adding the unwanted signal

- With the interfering signal present, a 100 % duty cycle CW signal is inserted as the unwanted signal. The frequency and the level are provided in table 10 (clause 4.3.2.6.3.2.2) for Frame Based Equipment or in table 11 (clause 4.3.2.6.3.2.3) for Load Based Equipment.
- The spectrum analyser shall be used to monitor the transmissions of the UUT on the selected operating channel. This may require the spectrum analyser sweep to be triggered by the start of the unwanted signal.
- Using the procedure defined in clause 5.4.6.2.1.5, it shall be verified that:
 - i) The UUT shall not resume normal transmissions on the current operating channel as long as both the interference and unwanted signals remain present.

To verify that the UUT is not resuming normal transmissions as long as the interference and unwanted signals are present, the monitoring time may need to be 60 s or more.
 - ii) The UUT may continue to have Short Control Signalling Transmissions on the operating channel while the interfering and unwanted signals are present. These transmissions shall comply with the limits defined in clause 4.3.2.6.4.2.

The verification of the Short Control Signalling transmissions may require the analyser settings to be changed (e.g. sweep time).

Step 6: Removing the interference and unwanted signal

- On removal of the interference and unwanted signals the UUT is allowed to start transmissions again on this channel; however, this is not a requirement and, therefore, does not require testing.

Step 7:

- Step 2 to step 6 shall be repeated for each of the frequencies to be tested.

5.4.6.2.1.5 Generic test procedure for measuring channel/frequency usage

This is a generic test method to evaluate transmissions on the operating (hopping) frequency being investigated. This test is performed as part of the procedures described in clause 5.4.6.2.1.2 to clause 5.4.6.2.1.4.

The test procedure shall be as follows:

Step 1:

- The analyser shall be set as follows:
 - Centre Frequency: Equal to the hopping frequency or centre frequency of the channel being investigated.
 - Frequency Span: 0 Hz.
 - RBW: ~ 50 % of the Occupied Channel Bandwidth (if the analyser does not support this setting, the highest available setting shall be used).
 - VBW: \geq RBW (if the analyser does not support this setting, the highest available setting shall be used).
 - Detector Mode: RMS.
 - Sweep time: > the Channel Occupancy Time. It shall be noted that if the Channel Occupancy Time is non-contiguous (for non-LBT based Frequency Hopping Equipment), the sweep time shall be sufficient to cover the period over which the Channel Occupancy Time is spread out.

- Number of sweep points: The time resolution has to be sufficient to meet the maximum measurement uncertainty of 5 % for the period to be measured. In most cases, the Idle Period is the shortest period to be measured and thereby defining the time resolution. If the Channel Occupancy Time is non-contiguous (non-LBT based frequency hopping equipment), there is no Idle Period to be measured and therefore the time resolution can be increased (e.g. to 5 % of the dwell time) to cover the period over which the Channel Occupancy Time is spread out, without resulting in too high a number of sweep points for the analyser.

EXAMPLE 1: For a Channel Occupancy Time of 60 ms, the minimum Idle Period is 3 ms, hence the minimum time resolution should be < 150 μ s.

EXAMPLE 2: For a Channel Occupancy Time of 2 ms, the minimum Idle Period is 100 μ s, hence the minimum time resolution should be < 5 μ s.

EXAMPLE 3: In case of an equipment using the non-contiguous Channel Occupancy Time approach (40 ms) and using 79 hopping frequencies with a dwell time of 3,75 ms, the total period over which the Channel Occupancy Time is spread out is 3,2 s. With a time resolution 0,1875 ms (5 % of the dwell time), the minimum number of sweep points is ~ 17 000.

- Trace mode: Clear / Write
- Trigger: Video

In case of Frequency Hopping Equipment, the data points resulting from transmissions on the hopping frequency being investigated are assumed to have much higher levels compared to data points resulting from transmissions on adjacent hopping frequencies. If a clear determination between these transmissions is not possible, the RBW in step 1 shall be further reduced. In addition, a channel filter may be used.

Step 2:

- Save the trace data to a file for further analysis by a computing device using an appropriate software application or program.

Step 3:

- Identify the data points related to the frequency being investigated by applying a threshold.
- Count the number of consecutive data points identified as resulting from a single transmission on the frequency being investigated and multiply this number by the time difference between two consecutive data points. Repeat this for all the transmissions within the measurement window.
- For measuring idle or silent periods, count the number of consecutive data points identified as resulting from a single transmitter off period on the frequency being investigated and multiply this number by the time difference between two consecutive data points. Repeat this for all the transmitter off periods within the measurement window

5.4.6.2.2 Radiated measurements

When performing radiated measurements on equipment with dedicated antennas, measurements shall be repeated for each alternative dedicated antenna.

A test site as described in annex B and applicable measurement procedures as described in annex C shall be used.

The test procedure is further as described under clause 5.4.6.2.1.

5.4.7 Occupied Channel Bandwidth

5.4.7.1 Test conditions

See clause 5.1 for the environmental test conditions. These measurements shall only be performed at normal test conditions.

In case of conducted measurements on smart antenna systems (equipment with multiple transmit chains) measurements need only to be performed on one of the active transmit chains (antenna outputs).

For equipment using FHSS modulation and which have overlapping channels, special software might be required to force the UUT to hop or transmit on a single Hopping Frequency.

The measurement shall be performed only on the lowest and the highest frequency within the stated frequency range. The frequencies on which the tests were performed shall be recorded.

If the equipment can operate with different Nominal Channel Bandwidths (e.g. 20 MHz and 40 MHz), then each channel bandwidth shall be tested separately.

5.4.7.2 Test method

5.4.7.2.1 Conducted measurement

The measurement procedure shall be as follows:

Step 1:

Connect the UUT to the spectrum analyser and use the following settings:

- Centre Frequency: The centre frequency of the channel under test
- Resolution BW: ~ 1 % of the span without going below 1 %
- Video BW: $3 \times \text{RBW}$
- Frequency Span: $2 \times \text{Nominal Channel Bandwidth}$
- Detector Mode: RMS
- Trace Mode: Max Hold
- Sweep time: 1 s

Step 2:

Wait for the trace to stabilize.

Find the peak value of the trace and place the analyser marker on this peak.

Step 3:

Use the 99 % bandwidth function of the spectrum analyser to measure the Occupied Channel Bandwidth of the UUT. This value shall be recorded.

Make sure that the power envelope is sufficiently above the noise floor of the analyser to avoid the noise signals left and right from the power envelope being taken into account by this measurement.

5.4.7.2.2 Radiated measurement

The test set up as described in annex B and the applicable measurement procedures described in annex C shall be used. Alternatively, a test fixture may be used.

The test procedure is as described under clause 5.4.7.2.1.

5.4.8 Transmitter unwanted emissions in the out-of-band domain

5.4.8.1 Test conditions

See clause 5.1 for the environmental test conditions.

These measurements shall only be performed at normal test conditions.

For equipment using FHSS modulation, the measurements shall be performed during normal operation (hopping).

For equipment using wide band modulations other than FHSS, the measurement shall be performed at the lowest and the highest channel on which the equipment can operate. These operating channels shall be recorded.

The equipment shall be configured to operate under its worst case situation with respect to output power.

If the equipment can operate with different Nominal Channel Bandwidths (e.g. 20 MHz and 40 MHz), then each channel bandwidth shall be tested separately.

5.4.8.2 Test method

5.4.8.2.1 Conducted measurement

The applicable mask is defined by the measurement results from the tests performed under clause 5.4.7 (Occupied Channel Bandwidth).

The Out-of-band emissions within the different horizontal segments of the mask provided in figure 1 and figure 3 shall be measured using the procedure in step 1 to step 6 below. This method assumes the spectrum analyser is equipped with the Time Domain Power option.

Step 1:

- Connect the UUT to the spectrum analyser and use the following settings:
 - Centre Frequency: 2 484 MHz
 - Span: 0 Hz
 - Resolution BW: 1 MHz
 - Filter mode: Channel filter
 - Video BW: 3 MHz
 - Detector Mode: RMS
 - Trace Mode: Max Hold
 - Sweep Mode: Continuous
 - Sweep Points: Sweep Time [s] / (1 μ s) or 5 000 whichever is greater
 - Trigger Mode: Video trigger; in case video triggering is not possible, an external trigger source may be used
 - Sweep Time: > 120 % of the duration of the longest burst detected during the measurement of the RF Output Power

Step 2 (segment 2 483,5 MHz to 2 483,5 MHz + BW):

- Adjust the trigger level to select the transmissions with the highest power level.
- For frequency hopping equipment operating in a normal hopping mode, the different hops will result in signal bursts with different power levels. In this case the burst with the highest power level shall be selected.

- Set a window (start and stop lines) to match with the start and end of the burst and in which the RMS power shall be measured using the Time Domain Power function.
- Select RMS power to be measured within the selected window and note the result which is the RMS power within this 1 MHz segment (2 483,5 MHz to 2 484,5 MHz). Compare this value with the applicable limit provided by the mask.
- Increase the centre frequency in steps of 1 MHz and repeat this measurement for every 1 MHz segment within the range 2 483,5 MHz to 2 483,5 MHz + BW. The centre frequency of the last 1 MHz segment shall be set to 2 483,5 MHz + BW - 0,5 MHz (which means this may partly overlap with the previous 1 MHz segment).

Step 3 (segment 2 483,5 MHz + BW to 2 483,5 MHz + 2BW):

- Change the centre frequency of the analyser to 2 484 MHz + BW and perform the measurement for the first 1 MHz segment within range 2 483,5 MHz + BW to 2 483,5 MHz + 2BW. Increase the centre frequency in 1 MHz steps and repeat the measurements to cover this whole range. The centre frequency of the last 1 MHz segment shall be set to 2 483,5 MHz + 2 BW - 0,5 MHz (which means this may partly overlap with the previous 1 MHz segment).

Step 4 (segment 2 400 MHz - BW to 2 400 MHz):

- Change the centre frequency of the analyser to 2 399,5 MHz and perform the measurement for the first 1 MHz segment within range 2 400 MHz - BW to 2 400 MHz. Reduce the centre frequency in 1 MHz steps and repeat the measurements to cover this whole range. The centre frequency of the last 1 MHz segment shall be set to 2 400 MHz - BW + 0,5 MHz (which means this may partly overlap with the previous 1 MHz segment).

Step 5 (segment 2 400 MHz - 2BW to 2 400 MHz - BW):

- Change the centre frequency of the analyser to 2 399,5 MHz - BW and perform the measurement for the first 1 MHz segment within range 2 400 MHz - 2BW to 2 400 MHz - BW. Reduce the centre frequency in 1 MHz steps and repeat the measurements to cover this whole range. The centre frequency of the last 1 MHz segment shall be set to 2 400 MHz - 2BW + 0,5 MHz (which means this may partly overlap with the previous 1 MHz segment).

Step 6:

- In case of conducted measurements on equipment with a single transmit chain, the declared antenna assembly gain G in dBi shall be added to the results for each of the 1 MHz segments and compared with the limits provided by the mask given in figure 1 or figure 3. If more than one antenna assembly is intended for this power setting, the antenna with the highest gain shall be considered.
- In case of conducted measurements on smart antenna systems (equipment with multiple transmit chains), the measurements need to be repeated for each of the active transmit chains. The declared antenna assembly gain G in dBi for a single antenna shall be added to these results. If more than one antenna assembly is intended for this power setting, the antenna with the highest gain shall be considered. Comparison with the applicable limits shall be done using any of the options given below:
 - Option 1: the results for each of the transmit chains for the corresponding 1 MHz segments shall be added. The additional beamforming gain Y in dB shall be added as well and the resulting values compared with the limits provided by the mask given in figure 1 or figure 3.
 - Option 2: the limits provided by the mask given in figure 1 or figure 3 shall be reduced by $10 \times \log_{10}(A_{ch})$ and the additional beamforming gain Y in dB. The results for each of the transmit chains shall be individually compared with these reduced limits.

NOTE: A_{ch} refers to the number of active transmit chains.

It shall be recorded whether the equipment complies with the mask provided in figure 1 or figure 3.

5.4.8.2.2 Radiated measurement

The test set up as described in annex B and the applicable measurement procedures described in annex C shall be used. Alternatively a test fixture may be used.

The test procedure is as described under clause 5.4.8.2.1.

5.4.9 Transmitter unwanted emissions in the spurious domain

5.4.9.1 Test conditions

See clause 5.1 for the environmental test conditions. These measurements shall only be performed at normal test conditions.

The level of spurious emissions shall be measured as, either:

- a) their power in a specified load (conducted spurious emissions) and their effective radiated power when radiated by the cabinet or structure of the equipment (cabinet radiation); or
- b) their effective radiated power when radiated by cabinet and antenna in case of integral antenna equipment with no antenna connectors.

For equipment using FHSS modulation, the measurements may be performed when normal hopping is disabled. In this case measurements need to be performed when operating at the lowest and the highest hopping frequency. When this is not possible, the measurement shall be performed during normal operation (hopping).

For equipment using wide band modulations other than FHSS, the measurement shall be performed at the lowest and the highest channel on which the equipment can operate. These operating channels shall be recorded.

The equipment shall be configured to operate under its worst case situation with respect to output power.

If the equipment can operate with different Nominal Channel Bandwidths (e.g. 20 MHz and 40 MHz), then the equipment shall be configured to operate under its worst case situation with respect to spurious emissions.

5.4.9.2 Test method

5.4.9.2.1 Conducted measurement

5.4.9.2.1.1 Introduction

The spectrum in the spurious domain (see figure 1 or figure 3) shall be searched for emissions that exceed the limit values given in table 4 or table 12 or that come to within 6 dB below these limits. Each occurrence shall be recorded.

The measurement procedure contains 2 parts.

5.4.9.2.1.2 Pre-scan

The procedure in step 1 to step 4 below shall be used to identify potential unwanted emissions of the UUT.

Step 1:

The sensitivity of the measurement set-up should be such that the noise floor is at least 12 dB below the limits given in table 4 or table 12.

Step 2:

The emissions over the range 30 MHz to 1 000 MHz shall be identified.

Spectrum analyser settings:

- Resolution bandwidth: 100 kHz
- Video bandwidth: 300 kHz
- Filter type: 3 dB (Gaussian)
- Detector mode: Peak

- Trace Mode: Max Hold
- Sweep Points: $\geq 19\,400$; for spectrum analysers not supporting this high number of sweep points, the frequency band may be segmented
- Sweep time: For non continuous transmissions (duty cycle less than 100 %), the sweep time shall be sufficiently long, such that for each 100 kHz frequency step, the measurement time is greater than two transmissions of the UUT, on any channel

For Frequency Hopping equipment operating in a normal operating (hopping not disabled) mode, the sweep time shall be further increased to capture multiple transmissions on any of the hopping frequencies

The above sweep time setting may result in long measuring times in case of frequency hopping equipment. To avoid such long measuring times, an FFT analyser may be used

Allow the trace to stabilize. Any emissions identified during the sweeps above and that fall within the 6 dB range below the applicable limit or above, shall be individually measured using the procedure in clause 5.4.9.2.1.3 and compared to the limits given in table 4 or table 12.

Step 3:

The emissions over the range 1 GHz to 12,75 GHz shall be identified.

Spectrum analyser settings:

- Resolution bandwidth: 1 MHz
- Video bandwidth: 3 MHz
- Filter type: 3 dB (Gaussian)
- Detector mode: Peak
- Trace Mode: Max Hold
- Sweep Points: $\geq 23\,500$; for spectrum analysers not supporting this high number of sweep points, the frequency band may be segmented
- Sweep time: For non continuous transmissions (duty cycle less than 100 %), the sweep time shall be sufficiently long, such that for each 1 MHz frequency step, the measurement time is greater than two transmissions of the UUT, on any channel

For Frequency Hopping equipment operating in a normal operating (hopping not disabled) mode, the sweep time shall be further increased to capture multiple transmissions on any of the hopping frequencies

The above sweep time setting may result in long measuring times in case of frequency hopping equipment. To avoid such long measuring times, an FFT analyser may be used

Allow the trace to stabilize. Any emissions identified during the sweeps above that fall within the 6 dB range below the applicable limit or above, shall be individually measured using the procedure in clause 5.4.9.2.1.3 and compared to the limits given in table 4 or table 12.

Frequency Hopping equipment may generate a block (or several blocks) of spurious emissions anywhere within the spurious domain. If this is the case, only the highest peak of each block of emissions shall be measured using the procedure in clause 5.4.9.2.1.3.

Step 4:

- In case of conducted measurements on smart antenna systems (equipment with multiple transmit chains), step 2 and step 3 need to be repeated for each of the active transmit chains (A_{ch}). The limits used to identify emissions during this pre-scan need to be reduced by $10 \times \log_{10}(A_{ch})$.

5.4.9.2.1.3 Measurement of the emissions identified during the pre-scan

The procedure in step 1 to step 4 below shall be used to accurately measure the individual unwanted emissions identified during the pre-scan measurements above. This method assumes the spectrum analyser has a Time Domain Power function.

Step 1:

The level of the emissions shall be measured using the following spectrum analyser settings:

- Measurement Mode: Time Domain Power
- Centre Frequency: Frequency of the emission identified during the pre-scan
- Resolution Bandwidth: 100 kHz (< 1 GHz) / 1 MHz (> 1 GHz)
- Video Bandwidth: 300 kHz (< 1 GHz) / 3 MHz (> 1 GHz)
- Frequency Span: Zero Span
- Sweep mode: Single Sweep
- Sweep time: > 120 % of the duration of the longest burst detected during the measurement of the RF Output Power
- Sweep points: Sweep time [μ s] / (1 μ s) with a maximum of 30 000
- Trigger: Video (burst signals) or Manual (continuous signals)
- Detector: RMS

Step 2:

Set a window where the start and stop indicators match the start and end of the burst with the highest level and record the value of the power measured within this window. If the spurious emission to be measured is a continuous transmission, the measurement window shall be set to match the start and stop times of the sweep.

Step 3:

In case of conducted measurements on smart antenna systems (equipment with multiple transmit chains), step 2 needs to be repeated for each of the active transmit chains (A_{ch}).

Sum the measured power (within the observed window) for each of the active transmit chains.

Step 4:

The value defined in step 3 shall be compared to the limits defined in table 4 or table 12.

5.4.9.2.2 Radiated measurement

The test site as described in annex B and applicable measurement procedures as described in annex C shall be used.

The test procedure is further as described under clause 5.4.9.2.1.

5.4.10 Receiver spurious emissions

5.4.10.1 Test conditions

See clause 5.1 for the environmental test conditions. These measurements shall only be performed at normal test conditions.

The level of spurious emissions shall be measured as, either:

- a) their power in a specified load (conducted spurious emissions) and their effective radiated power when radiated by the cabinet or structure of the equipment (cabinet radiation); or
- b) their effective radiated power when radiated by cabinet and antenna in case of integral antenna equipment with no temporary antenna connectors.

Testing shall be performed when the equipment is in a receive-only mode.

For equipment using wide band modulations other than FHSS, the measurement shall be performed at the lowest and the highest channel on which the equipment can operate. These frequencies shall be recorded.

For equipment using FHSS modulation, the measurements may be performed when normal hopping is disabled. In this case measurements need to be performed when operating at the lowest and the highest hopping frequency. These frequencies shall be recorded. When disabling the normal hopping is not possible, the measurement shall be performed during normal operation (hopping).

5.4.10.2 Test method

5.4.10.2.1 Conducted measurement

5.4.10.2.1.1 Introduction

In case of conducted measurements, the radio equipment shall be connected to the measuring equipment via an attenuator.

The spectrum in the spurious domain (see figure 1 or figure 3) shall be searched for emissions that exceed the limit values given in table 5 or table 13 or that come to within 6 dB below these limits. Each occurrence shall be recorded.

The measurement procedure contains 2 parts.

5.4.10.2.1.2 Pre-scan

The procedure in step 1 to step 4 below shall be used to identify potential unwanted emissions of the UUT.

Step 1:

The sensitivity of the spectrum analyser should be such that the noise floor is at least 12 dB below the limits given in table 5 or table 13.

Step 2:

The emissions over the range 30 MHz to 1 000 MHz shall be identified.

Spectrum analyser settings:

- Resolution bandwidth: 100 kHz
- Video bandwidth: 300 kHz
- Filter type: 3 dB (Gaussian)
- Detector mode: Peak
- Trace Mode: Max Hold

- Sweep Points: $\geq 19\,400$
- Sweep time: Auto

Wait for the trace to stabilize. Any emissions identified during the sweeps above and that fall within the 6 dB range below the applicable limit or above, shall be individually measured using the procedure in clause 5.4.10.2.1.3 and compared to the limits given in table 5 or table 13.

Step 3:

The emissions over the range 1 GHz to 12,75 GHz shall be identified.

Spectrum analyser settings:

- Resolution bandwidth: 1 MHz
- Video bandwidth: 3 MHz
- Filter type: 3 dB (Gaussian)
- Detector mode: Peak
- Trace Mode: Max Hold
- Sweep Points: $\geq 23\,500$; for spectrum analysers not supporting this high number of sweep points, the frequency band may be segmented
- Sweep time: Auto

Wait for the trace to stabilize. Any emissions identified during the sweeps above that fall within the 6 dB range below the applicable limit or above, shall be individually measured using the procedure in clause 5.4.10.2.1.3 and compared to the limits given in table 5 or table 13.

Frequency Hopping equipment may generate a block (or several blocks) of spurious emissions anywhere within the spurious domain. If this is the case, only the highest peak of each block of emissions shall be measured using the procedure in clause 5.4.10.2.1.3.

Step 4:

- In case of conducted measurements on smart antenna systems (equipment with multiple receive chains), step 2 and step 3 need to be repeated for each of the active receive chains A_{ch} . The limits used to identify emissions during this pre-scan need to be reduced by $10 \times \log_{10} A_{ch}$.

5.4.10.2.1.3 Measurement of the emissions identified during the pre-scan

The procedure in step 1 to step 4 below shall be used to accurately measure the individual unwanted emissions identified during the pre-scan measurements above. This method assumes the spectrum analyser has a Time Domain Power function.

Step 1:

The level of the emissions shall be measured using the following spectrum analyser settings:

- Measurement Mode: Time Domain Power
- Centre Frequency: Frequency of the emission identified during the pre-scan
- Resolution Bandwidth: 100 kHz (< 1 GHz) / 1 MHz (> 1 GHz)
- Video Bandwidth: 300 kHz (< 1 GHz) / 3 MHz (> 1 GHz)
- Frequency Span: Zero Span
- Sweep mode: Single Sweep

- Sweep time: 30 ms
- Sweep points: $\geq 30\ 000$
- Trigger: Video (for burst signals) or Manual (for continuous signals)
- Detector: RMS

Step 2:

Set a window where the start and stop indicators match the start and end of the burst with the highest level and record the value of the power measured within this window. If the spurious emission to be measured is a continuous transmission, the measurement window shall be set to the start and stop times of the sweep.

Step 3:

In case of conducted measurements on smart antenna systems (equipment with multiple receive chains), step 2 needs to be repeated for each of the active receive chains A_{ch} .

Sum the measured power (within the observed window) for each of the active receive chains.

Step 4:

The value defined in step 3 shall be compared to the limits defined in table 5 and table 13.

5.4.10.2.2 Radiated measurement

The test site as described in annex B and applicable measurement procedures as described in annex C shall be used.

The test procedure is further as described under clause 5.4.10.2.1.

5.4.11 Receiver Blocking

5.4.11.1 Test conditions

See clause 5.1 for the environmental test conditions. These measurements shall only be performed at normal test conditions.

For non-frequency hopping equipment, having more than one operating channel, the equipment shall be tested operating at both the lowest and highest operating channels. Equipment which can change their operating channel automatically (adaptive channel allocation), and where this function cannot be disabled, shall be tested as a frequency hopping equipment.

If the equipment can be configured to operate with different Nominal Channel Bandwidths (e.g. 20 MHz and 40 MHz) and different data rates, then the combination of the smallest channel bandwidth and the lowest data rate for this channel bandwidth which still allows the equipment to operate as intended shall be used. This mode of operation shall be aligned with the performance criteria defined in clause 4.3.1.12.3 or clause 4.3.2.11.3 as declared by the manufacturer (see clause 5.4.1 t)) and shall be described in the test report.

It shall be verified that this performance criteria as declared by the manufacturer is achieved.

5.4.11.2 Test Method

5.4.11.2.1 Conducted measurements

For systems using multiple receive chains only one chain (antenna port) need to be tested. All other receiver inputs shall be terminated.

Figure 6 shows the test set-up which can be used for performing the receiver blocking test.

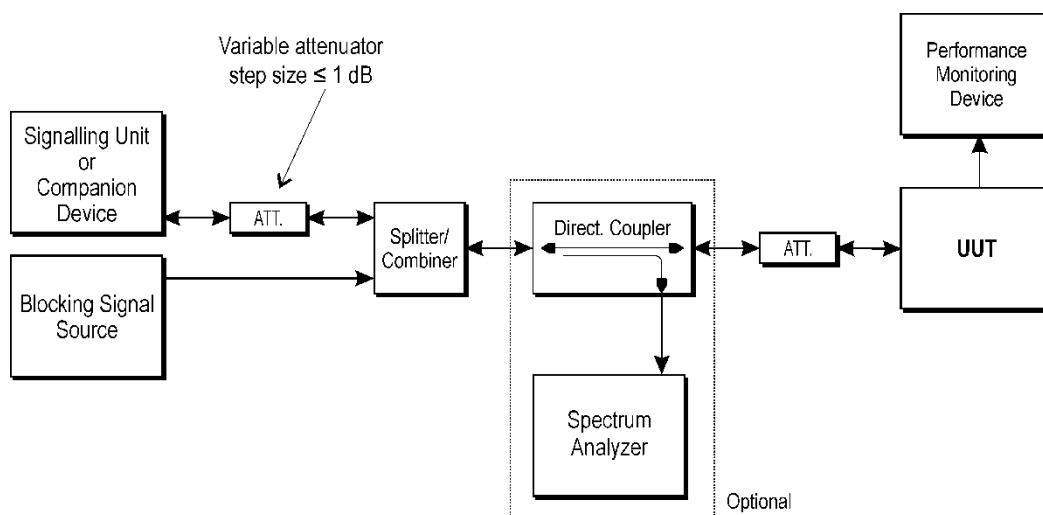

Figure 6: Test Set-up for receiver blocking

The procedure in step 1 to step 6 below shall be used to verify the receiver blocking requirement as described in clause 4.3.1.12 or clause 4.3.2.11.

Table 6, table 7 and table 8 in clause 4.3.1.12.4 contain the applicable blocking frequencies and blocking levels for each of the receiver categories for testing Receiver Blocking on frequency hopping equipment.

Table 14, table 15 and table 16 in clause 4.3.2.11.4 contain the applicable blocking frequencies and blocking levels for each of the receiver categories for testing Receiver Blocking on equipment using wide band modulations other than FHSS.

Step 1:

- For non-frequency hopping equipment, the UUT shall be set to the lowest operating channel.

Step 2:

- The blocking signal generator is set to the first frequency as defined in the appropriate table corresponding to the receiver category and type of equipment.

Step 3:

- With the blocking signal generator switched off, a communication link is established between the UUT and the associated companion device using the test setup shown in figure 6. The attenuation of the variable attenuator shall be increased in 1 dB steps to a value at which the minimum performance criteria as specified in clause 4.3.1.12.3 or clause 4.3.2.11.3 is still met. The resulting level for the wanted signal at the input of the UUT is P_{\min} .
- This signal level (P_{\min}) is increased by the value provided in the table corresponding to the receiver category and type of equipment.

Step 4:

- The blocking signal at the UUT is set to the level provided in the table corresponding to the receiver category and type of equipment. It shall be verified and recorded in the test report that the performance criteria as specified in clause 4.3.1.12.3 or clause 4.3.2.11.3 is met.

Step 5:

- Repeat step 4 for each remaining combination of frequency and level for the blocking signal as provided in the table corresponding to the receiver category and type of equipment.

Step 6:

- For non-frequency hopping equipment, repeat step 2 to step 5 with the UUT operating at the highest operating channel.

5.4.11.2.2 Radiated measurements

When performing radiated measurements on equipment with dedicated antennas, measurements shall be repeated for each alternative dedicated antenna.

A test site as described in annex B and applicable measurement procedures as described in annex C shall be used.

The test procedure is further as described under clause 5.4.11.2.1.

The level of the blocking signal at the UUT referred to in step 4 is assumed to be the level in front of the UUT antenna(s). The UUT shall be positioned with its main beam pointing towards the antenna radiating the blocking signal. The position recorded in clause 5.4.2.2.2 can be used.

Annex A (informative): Relationship between the present document and the essential requirements of Directive 2014/53/EU

The present document has been prepared under the Commission's standardisation request C(2015) 5376 final [i.14] to provide one voluntary means of conforming to the essential requirements of Directive 2014/53/EU on the harmonisation of the laws of the Member States relating to the making available on the market of radio equipment and repealing Directive 1999/5/EC [i.1].

Once the present document is cited in the Official Journal of the European Union under that Directive, compliance with the normative clauses of the present document given in table A.1 confers, within the limits of the scope of the present document, a presumption of conformity with the corresponding essential requirements of that Directive, and associated EFTA regulations.

Table A.1: Relationship between the present document and the essential requirements of Directive 2014/53/EU

Harmonised Standard ETSI EN 300 328				
Requirement			Requirement Conditionality	
No	Description	Reference: Clause No	U/C	Condition
1	RF Output Power	4.3.1.2 or 4.3.2.2	U	
2	Power Spectral Density	4.3.2.3	C	Only for equipment using wide band modulations other than FHSS
3	Duty cycle, Tx-Sequence, Tx-gap	4.3.1.3 or 4.3.2.4	C	Only for non-Adaptive equipment
4	Accumulated Transmit time, Frequency Occupation & Hopping Sequence	4.3.1.4	C	Only for FHSS equipment
5	Hopping Frequency Separation	4.3.1.5	C	Only for FHSS equipment
6	Medium Utilization	4.3.1.6 or 4.3.2.5	C	Only for non-Adaptive equipment
7	Adaptivity	4.3.1.7 or 4.3.2.6	C	Only for Adaptive equipment
8	Occupied Channel Bandwidth	4.3.1.8 or 4.3.2.7	U	
9	Transmitter unwanted emissions in the OOB domain	4.3.1.9 or 4.3.2.8	U	
10	Transmitter unwanted emissions in the spurious domain	4.3.1.10 or 4.3.2.9	U	
11	Receiver spurious emissions	4.3.1.11 or 4.3.2.10	U	
12	Receiver Blocking	4.3.1.12 or 4.3.2.11	U	
13	Geo-location capability	4.3.1.13 or 4.3.2.12	C	Only for equipment with geo-location capability

Key to columns:

Requirement:

No A unique identifier for one row of the table which may be used to identify a requirement.

Description A textual reference to the requirement.

Clause Number Identification of clause(s) defining the requirement in the present document unless another document is referenced explicitly.

Requirement Conditionality:

U/C Indicates whether the requirement is unconditionally applicable (U) or is conditional upon the manufacturer's claimed functionality of the equipment (C).

Condition Explains the conditions when the requirement is or is not applicable for a requirement which is classified "conditional".

Presumption of conformity stays valid only as long as a reference to the present document is maintained in the list published in the Official Journal of the European Union. Users of the present document should consult frequently the latest list published in the Official Journal of the European Union.

Other Union legislation may be applicable to the product(s) falling within the scope of the present document.

Annex B (normative): Test sites and arrangements for radiated measurement

B.1 Introduction

This annex introduces three most commonly available test sites and a test fixture, to be used in the radiated measurements in accordance with the present document.

Subsequently, the following items are described:

- Open Area Test Site (OATS);
- Semi Anechoic Room (SAR);
- Fully Anechoic Room (FAR);
- Test fixture for relative measurements.

The first three are generally referred to as free field test sites. Both absolute and relative measurements can be performed on these sites. They are described in clause B.2. Clause B.3 describes the antennas used in these test sites. The test fixture can only be used for relative measurements, and are described in clause B.4.

Where absolute measurements are to be carried out, the chamber should be verified. A detailed verification procedure is described in clause 6 of ETSI TR 102 273-4 [i.10] for the OATS, in clause 6 of ETSI TR 102 273-3 [i.9] for the SAR, and in clause 6 of ETSI TR 102 273-2 [i.8] for the FAR.

Information for calculating the measurement uncertainty of measurements on one of these test sites can be found in ETSI TR 100 028-1 [i.15] and ETSI TR 100 028-2 [i.11], ETSI TR 102 273-2 [i.8], ETSI TR 102 273-3 [i.9] and ETSI TR 102 273-4 [i.10].

In addition to the above, clause B.7 in this annex describes the Interference Signal to be used for the Adaptivity Tests.

B.2 Radiation test sites

B.2.1 Open Area Test Site (OATS)

An Open Area Test Site comprises a turntable at one end and an antenna mast of variable height at the other end above a ground plane which, in the ideal case, is perfectly conducting and of infinite extent. In practice, while good conductivity can be achieved, the ground plane size has to be limited. A typical Open Area Test Site is shown in figure B.1.

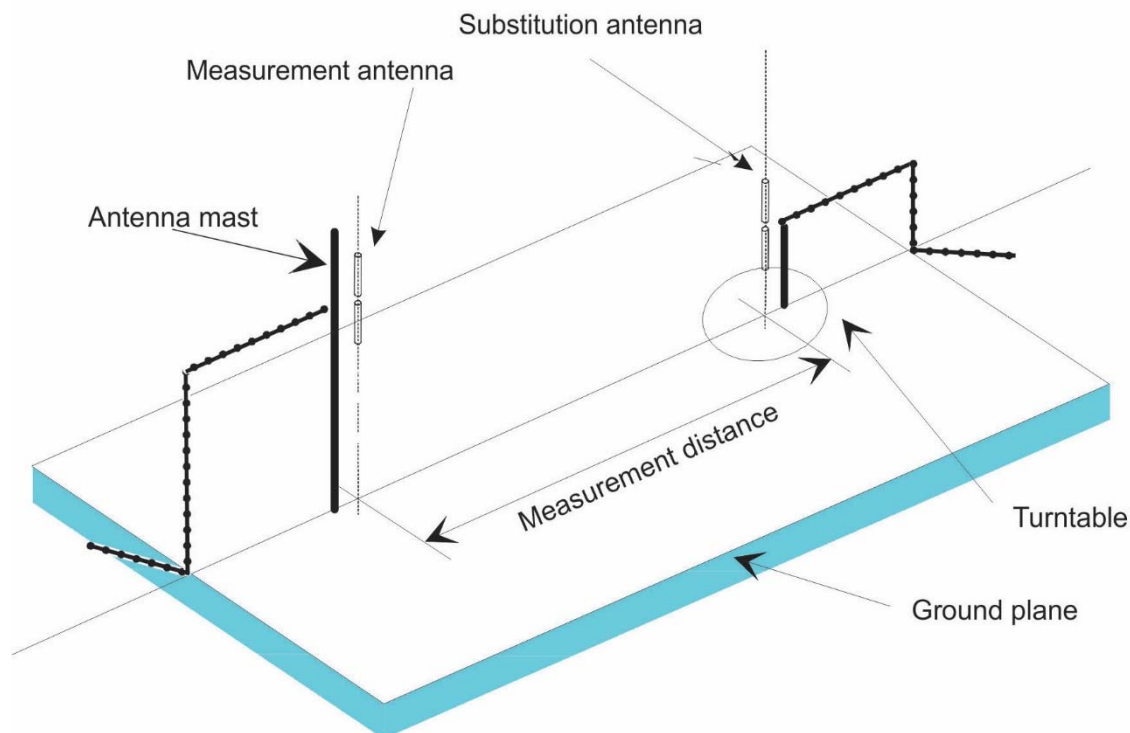

Figure B.1: A typical Open Area Test Site

The ground plane creates a wanted reflection path, such that the signal received by the receiving antenna is the sum of the signals received from the direct and reflected transmission paths. The phasing of these two signals creates a unique received level for each height of the transmitting antenna (or UUT) and the receiving antenna above the ground plane.

The antenna mast provides a variable height facility (from 1 m to 4 m) so that the position of the measurement antenna can be optimized for maximum coupled signal between antennas or between a UUT and the measurement antenna.

A turntable is capable of rotation through 360° in the horizontal plane and it is used to support the test sample (UUT) at a suitable height, usually 1,5 m above the ground plane.

The measurement distance and minimum chamber dimensions can be found in clause B.2.4. The distance used in actual measurements shall be recorded with the test results.

Further information on Open Area Test Sites can be found in ETSI TR 102 273-4 [i.10].

B.2.2 Semi Anechoic Room

A Semi Anechoic Room - or anechoic chamber with a conductive ground plane - is an enclosure, usually shielded, whose internal walls and ceiling are covered with radio absorbing material. The floor, which is metallic, is not covered by absorbing material and forms the ground plane. The chamber usually contains an antenna mast at one end and a turntable at the other end. A typical anechoic chamber with a conductive ground plane is shown in figure B.2.

This type of test chamber attempts to simulate an ideal Open Area Test Site, whose primary characteristic is a perfectly conducting ground plane of infinite extent.

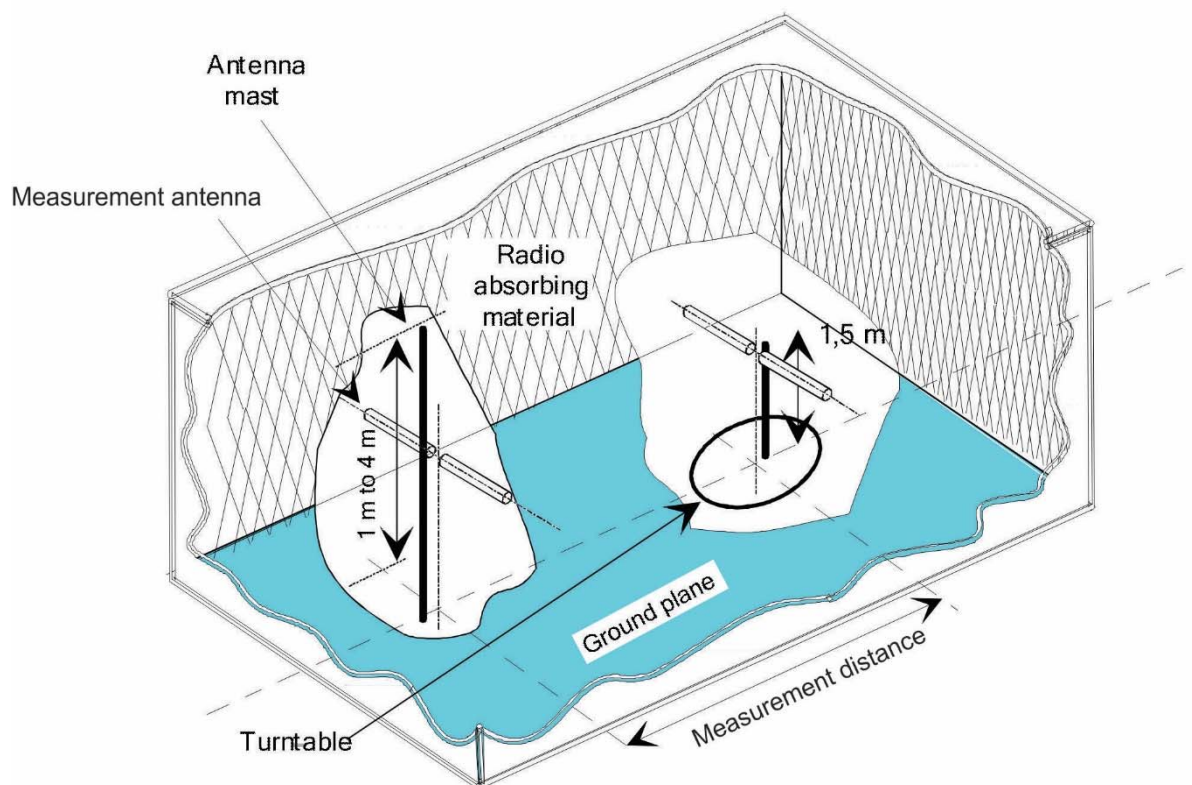

Figure B.2: A typical Semi Anechoic Room

In this facility the ground plane creates a wanted reflection path, such that the signal received by the receiving antenna is the sum of the signals received from the direct and reflected transmission paths. The phasing of these two signals creates a unique received level for each height of the transmitting antenna (or UUT) and the receiving antenna above the ground plane.

The antenna mast provides a variable height facility (from 1 m to 4 m) so that the position of the measurement antenna can be optimized for maximum coupled signal between antennas or between a UUT and the measurement antenna.

A turntable is capable of rotation through 360° in the horizontal plane and it is used to support the test sample (UUT) at a suitable height, usually 1,5 m above the ground plane.

The measurement distance and minimum chamber dimensions can be found in clause B.2.4. The distance used in actual measurements shall be recorded with the test results.

Further information on Semi Anechoic Rooms can be found in ETSI TR 102 273-3 [i.9].

B.2.3 Fully Anechoic Room (FAR)

A Fully Anechoic Room is an enclosure, usually shielded, whose internal walls, floor and ceiling are covered with radio absorbing material. The chamber usually contains an antenna support at one end and a turntable at the other end. A typical Fully Anechoic Room is shown in figure B.3.

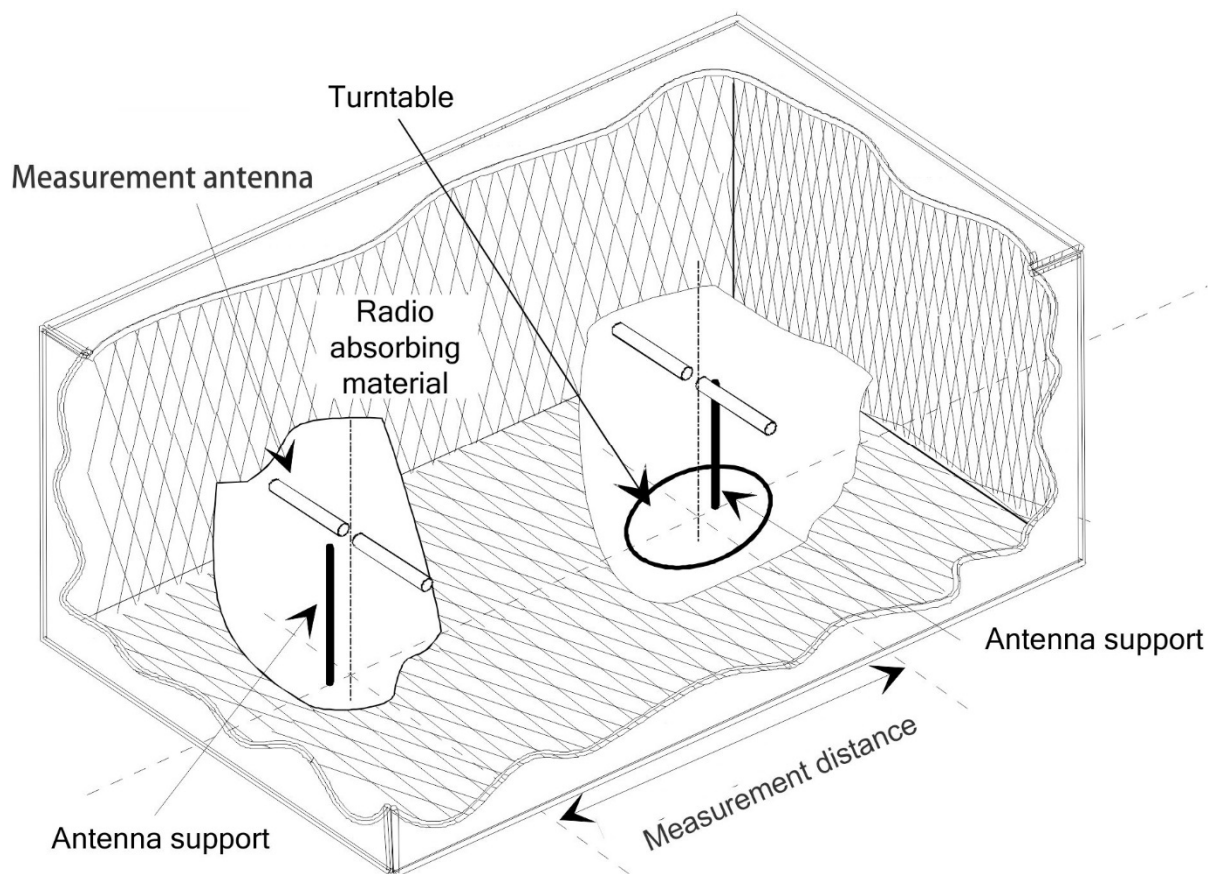

Figure B.3: A typical Fully Anechoic Room

The chamber shielding and radio absorbing material provide a controlled environment for testing purposes. This type of test chamber attempts to simulate free space conditions.

The shielding provides a test space, with reduced levels of interference from ambient signals and other outside effects, whilst the radio absorbing material minimizes unwanted reflections from the walls and ceiling which can influence the measurements. The shielding should be sufficient to eliminate interference from the external environment that would mask any signals that have to be measured.

A turntable is capable of rotation through 360° in the horizontal plane and it is used to support the UUT at a suitable height (e.g. 1 m) above the absorbing material.

The measurement distance and minimum chamber dimensions can be found in clause B.2.4. The distance used in actual measurements shall be recorded with the test results.

Further information on Fully Anechoic Rooms can be found in ETSI TR 102 273-2 [i.8].

B.2.4 Measurement Distance

The measurement distance should be chosen in order to measure the UUT at far-field conditions. The minimum measurement distance between the equipment and the measurement antenna should be λ or $r_m \gg \frac{D^2}{\lambda}$, whichever is the greater.

λ = wavelength in m

r_m = minimum measurement distance between UUT and measurement antenna in m

D = largest dimension of physical aperture of the largest antenna in the measurement setup, in m

$\frac{D^2}{\lambda}$ = distance between outer boundary of radiated near field (Fresnel region) and inner boundary of the radiated far-field (Fraunhofer region) in m, also known as Rayleigh distance

For those measurements, where these conditions cannot be fulfilled and where the measurement distance would result in measurements in the near field (e.g. while measuring spurious emissions), this should be noted in the test report and the additional measurement uncertainty should be incorporated into the results.

B.3 Antennas

B.3.1 Introduction

Antennas are needed for the radiated measurements on the three test sites described in clause B.2. Depending on its use, the antenna is designated as "measurement antenna" or "substitution antenna".

B.3.2 Measurement antenna

The measurement antenna is used to determine the field from the UUT and then from the substitution antenna. When the test site is used for the measurement of receiver characteristics, the antenna is used as the transmitting device.

The measurement antenna should be mounted on a support capable of allowing the antenna to be used in either horizontal or vertical polarization. Additionally, on an OATS or SAR, the height of the centre of the antenna above the ground should be variable over the specified range (usually 1 m to 4 m).

In the frequency band 30 MHz to 1 000 MHz, biconical or logarithmic periodic dipole antennas (LPDA) are recommended. Above 1 GHz, horn antennas or logarithmic periodic dipole antennas are recommended.

The measurement antenna does not require an absolute calibration.

B.3.3 Substitution antenna

The substitution antenna shall be used to replace the equipment under test in substitution measurements.

The substitution antenna shall be suitable for the frequency range and the return loss of the antenna shall be taken into account when calculating the measurement uncertainty.

The reference point of the substitution antenna shall coincide with the volume centre of the UUT when its antenna is internal, or with the volume centre of the dedicated antenna, or the external antenna connector.

The distance between the lower extremity of the antenna and the ground shall be at least 30 cm.

The substitution antenna shall be calibrated. For below 1 GHz, the calibration is relative to a half wave dipole, while above 1 GHz, an isotropic radiator is the reference.

B.4 Test fixture

B.4.1 Conducted measurements and use of test fixture

Conducted measurements may be applied to equipment provided with a (temporary) antenna connector, e.g. by means of a spectrum analyser.

In the case of integral antenna equipment with no antenna connector(s) provided, a test fixture can be used to allow relative measurements to be performed at the extremes of temperature.

B.4.2 Description of the test fixture

The test fixture shall provide a means of coupling to the radio frequency output(s).

The nominal impedance of the external connection to the test fixture shall be 50 Ω at the working frequencies of the equipment.

The performance characteristics of this test fixture under normal and extreme conditions shall be such that:

- a) the coupling loss shall be limited to ensure a sufficient dynamic range of the setup;
- b) the variation of coupling loss with frequency shall not cause errors exceeding 2 dB in measurements using the test fixture;
- c) the coupling device shall not include any non-linear elements.

B.4.3 Using the test fixture for relative measurements

Step 1 to step 4 below describe the procedure for performing relative measurements for those requirements where testing needs to be repeated at different temperatures.

Step 1:

Perform the measurement under normal conditions on a test site for radiated measurements as described in annex B, clause B.2. This results in an absolute value which shall be recorded.

Step 2:

Place the equipment with the test fixture in the temperature chamber. Perform the same measurement at normal conditions in this environment and normalize the measuring equipment to get the same value as in step 1.

Step 3:

Take care that the test fixture coupling remains constant during the entire test.

Step 4:

The measurements shall be repeated for the extreme temperatures. Due to the normalization performed in step 2, the obtained values are the test result for this requirement.

B.5 Guidance on the use of radiation test sites

B.5.1 Introduction

This clause details procedures, test equipment arrangements and verification that should be carried out before any of the radiated tests are performed. These procedures are common to all types of test sites described in clause B.2.

The UUT shall be placed or mounted on a non-conductive support.

B.5.2 Power supplies for a battery-only powered UUT

In case of battery-only powered UUT, the preference is to perform testing using the UUT's battery.

Where this is not practical, tests may be performed using a power supply. The power leads should be connected to the UUT's supply terminals (and monitored with a digital voltmeter). Where possible, the battery should remain present and electrically isolated.

The presence of these power cables can affect the measurements. For this reason, they should be made "transparent" as far as the testing is concerned (e.g. the leads could be twisted together, loaded with ferrite beads, etc.).

B.5.3 Site preparation

The cables to the measuring and substitution antenna should be routed appropriately to minimize the impact on the measurement.

B.6 Coupling of signals

The presence of test leads (not associated with the UUT under normal operation) in the radiated field may cause a disturbance of that field and lead to additional measurement uncertainty. These disturbances can be minimized by using suitable coupling methods, offering signal isolation and minimum field disturbance (e.g. optical coupling).

Leads which are part of the UUT shall be arranged to reflect normal operation of the UUT.

B.7 Interference Signal used for Adaptivity Tests

The inference signal used in the adaptivity tests described in clause 5.4.6.2.1.2, clause 5.4.6.2.1.3 and clause 5.4.6.2.1.4, shall be a band limited noise signal with a 100 % duty cycle.

The flatness, bandwidth and power spectral density of the interference signal can be verified with the following procedure:

Connect the signal generator for generating the interference signal to a spectrum analyser and use the following settings.

- Centre Frequency: Equal to the channel frequency to be tested
- Span: $2 \times$ the nominal channel bandwidth
- Resolution BW: $\sim 1 \%$ of the nominal channel bandwidth
- Video BW: $3 \times$ the Resolution BW
- Sweep Points: $2 \times$ the Span divided by the Resolution BW; for spectrum analysers not supporting this number of sweep points, the frequency band may be segmented
- Detector: Peak
- Trace Mode: Trace Averaging
- Number of sweeps: Sufficient to let the signal stabilize
- Sweep time: Auto

The 99 % bandwidth (the bandwidth containing 99 % of the power) of this inference signal shall be within a range from 120 % to 200 % of the Occupied Channel Bandwidth of the UUT with a minimum of 5 MHz, while the difference between the lowest and highest level within the Occupied Channel Bandwidth of the UUT shall be maximum 4 dB.

The level of this interference signal can be measured with a spectrum analyser using the following settings:

- Centre Frequency: Equal to the channel frequency to be tested
- Span: Zero
- Resolution BW: 1 MHz
- Video BW: $3 \times$ the Resolution BW
- Filter: Channel
- Detector: RMS
- Trace Mode: Clear Write

- Number of sweeps: Single
- Sweep time: 1 s

Annex C (normative): Measurement procedures for radiated measurement

C.1 Introduction

This annex gives the general procedures for radiated measurements using the test sites and arrangements described in annex B.

Preferably, radiated measurements shall be performed in a FAR, see clause C.3. Radiated measurements in an OATS or SAR are described in clause C.2.

C.2 Radiated measurements in an OATS or SAR

Radiated measurements shall be performed with the aid of a measurement antenna and a substitution antenna in test sites described in annex B. The measurement set-up shall be calibrated according to the procedure defined in this annex. The UUT and the measurement antenna shall be oriented such as to obtain the maximum emitted power level. This position shall be recorded in the test report.

- a) The measurement antenna (device 2 in figure C.1) shall be oriented initially for vertical antenna polarization unless otherwise stated and the UUT (device 1 in figure C.1) shall be placed on the support in its normal position and switched on.
- b) The measurement equipment (device 3 in figure C.1) shall be connected to the measurement antenna (device 2 in figure C.1) as shown in figure C.1.

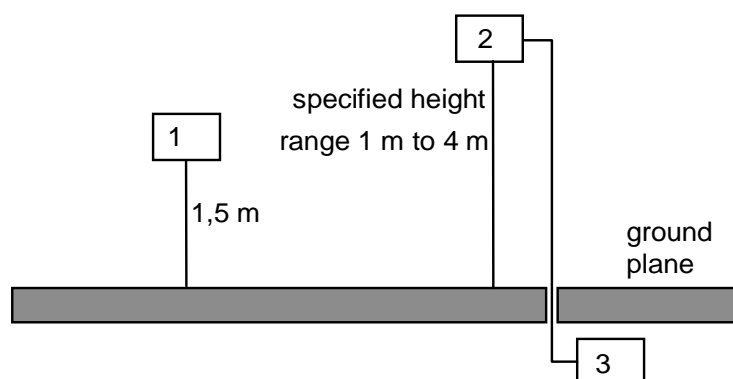

- 1) UUT
- 2) Measurement antenna
- 3) Measurement equipment

Figure C.1: Measurement arrangement No.1

- c) The UUT shall be rotated through 360° around its azimuth until the maximum signal level is received.
- d) The measurement antenna shall be raised or lowered over the specified height range until the maximum signal level is received. This level shall be recorded.
- e) This measurement shall be repeated for horizontal measurement antenna polarization.

C.3 Radiated measurements in a FAR

For radiated measurements using a FAR, the procedure is identical to the one described in clause C.2, except that the height scan is omitted.

C.4 Substitution measurement

To determine the absolute measurement value, a substitution measurement, as described in step 1 to step 6 below, has to be performed.

- 1) Replace the UUT with the substitution antenna as shown as device 1 in figure C.1. The substitution and the measurement antenna shall be vertically polarized.
- 2) Connect a signal generator to the substitution antenna and set it to the frequency being investigated.
- 3) If an OATS or an SAR is used, the measurement antenna shall be raised or lowered, to ensure that the maximum signal is received.
- 4) Subsequently, the power of the signal generator is adjusted until the same level is obtained as recorded from the UUT (see clause C.2).
- 5) The radiated power is equal to the power supplied by the signal generator, plus the gain of the substitution antenna, minus the cable loss.
- 6) This measurement shall be repeated in horizontal polarization.

For test sites with a fixed setup of the measurement antenna(s) and a reproducible positioning of the UUT, correction values from a verified site calibration may be used alternatively.

C.5 Guidance for testing technical requirements

C.5.1 Introduction

This clause provides guidance on how the various technical requirements can be verified using radiated measurements.

C.5.2 Test procedures and corresponding test sites

Table C.1 provides guidance on the test site to be used for each of the test procedures when performing radiated measurements on integral antenna equipment.

Table C.1: Test procedures and corresponding test sites

Test procedures for essential radio test suites	Clause	Corresponding test site - Clause number(s)
RF output power	5.4.2	B.2.1, B.2.2, B.2.3
Duty Cycle, Tx-sequence, Tx-gap	5.4.2	B.4.3 or B.2.1, B.2.2, B.2.3
Medium Utilization	5.4.2	B.4.3 in conjunction with the results from RF output power or B.2.1, B.2.2, B.2.3
Power Spectral Density	5.4.3	B.4.3 in conjunction with the results from RF output power or B.2.1, B.2.2, B.2.3
Accumulated Transmit time, Frequency Occupation and Hopping Sequence	5.4.4	B.4.3 or B.2.1, B.2.2, B.2.3
Hopping Frequency Separation	5.4.5	B.4.3 or B.2.1, B.2.2, B.2.3
Adaptivity	5.4.6	C.5.3
Occupied Channel Bandwidth	5.4.7	B.4.3
Transmitter unwanted emissions in the out-of-band domain	5.4.8	B.2.1, B.2.2, B.2.3
Transmitter unwanted emissions in the spurious domain	5.4.9	B.2.1, B.2.2, B.2.3
Receiver spurious emissions	5.4.10	B.2.1, B.2.2, B.2.3
Receiver Blocking	5.4.11	C.5.4

C.5.3 Guidance for testing Adaptivity (Channel Access Mechanism)

C.5.3.1 Introduction

This clause provides guidance on how the Adaptivity (see clause 4.3.1.7 or clause 4.3.2.6) requirement can be verified on integral antenna equipment using radiated measurements.

C.5.3.2 Measurement Set-up

Figure C.2 describes an example of a set-up that can be used to perform radiated adaptivity tests.

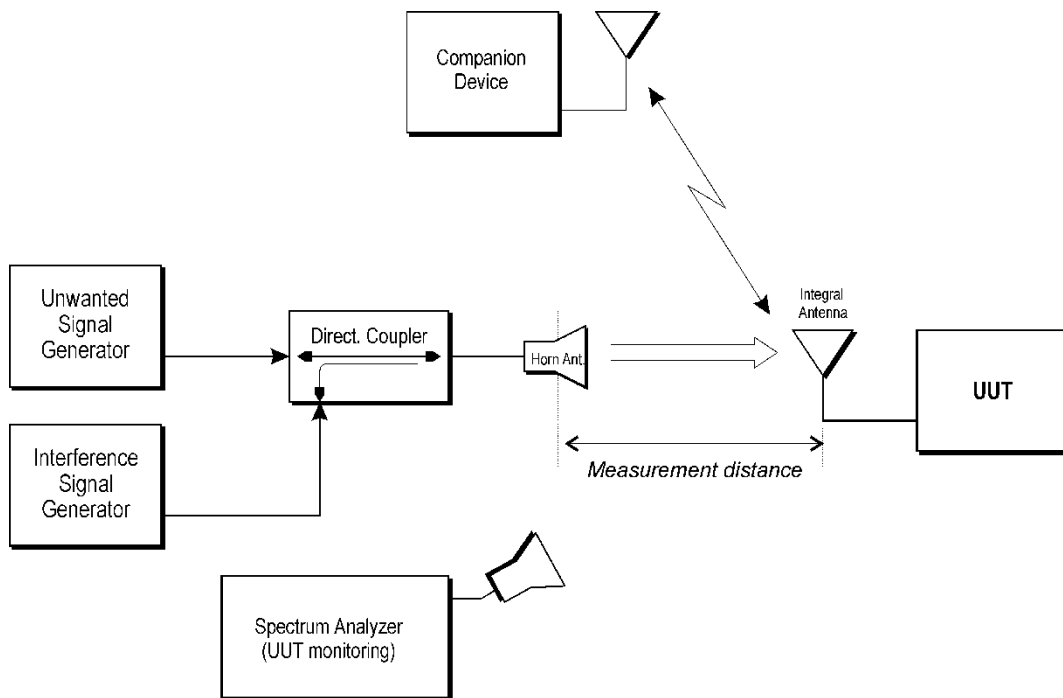

Figure C.2: Measurement Set-up

C.5.3.3 Calibration of the measurement Set-up

Before starting the actual measurement, the setup shall be calibrated. Figure C.3 shows an example of a set-up that can be used for calibrating the set-up given in figure C.2 using a substitution antenna and a spectrum analyser. It shall be verified that the levels of the interference and unwanted signals at the input of the substitution antenna correspond with the levels used for conducted measurements (see clause 5.4.6).

For test sites with a fixed setup of the measurement antenna(s) and a reproducible positioning of the UUT, correction values from a verified site calibration may be used alternatively.

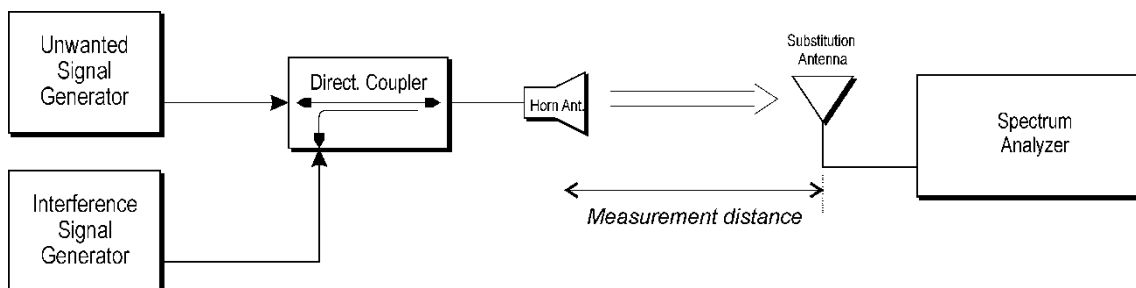

Figure C.3: Measurement Set-up - Calibration

C.5.3.4 Test method

The test procedure shall be as follows:

- Replace the substitution antenna with the UUT once the calibration is performed.
- The UUT shall be positioned for maximum e.i.r.p. towards the horn antenna.

The test method is further as described under clause 5.4.6.2.1.

C.5.4 Guidance for testing Receiver Blocking

C.5.4.1 Introduction

This clause provides guidance on how the Receiver Blocking (see clause 4.3.1.12 or clause 4.3.2.11) requirement can be verified on integral antenna equipment using radiated measurements.

C.5.4.2 Measurement Set-up

Figure C.4 describes an example of a set-up that can be used to perform radiated receiver blocking tests.

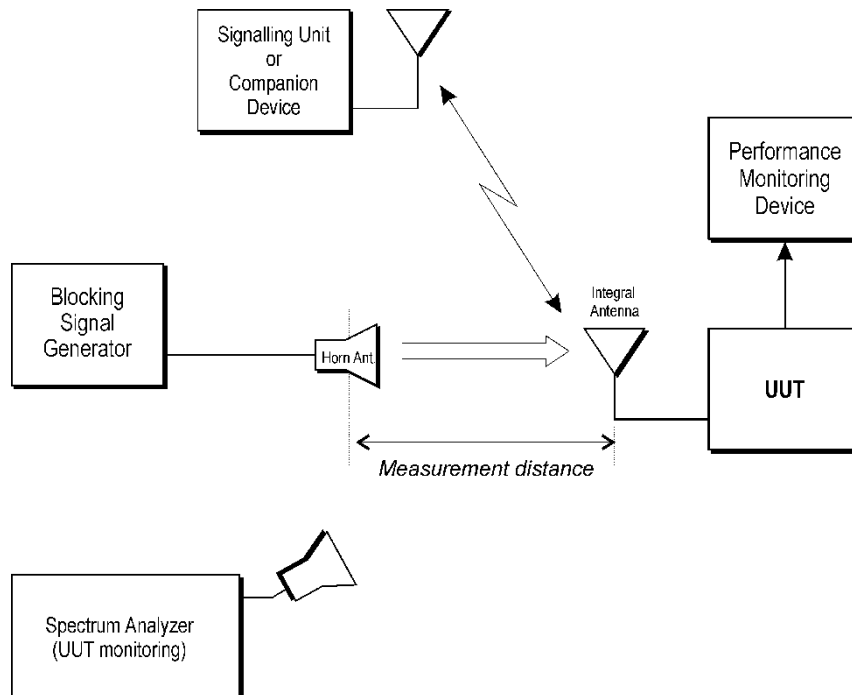

Figure C.4: Measurement Set-up

C.5.4.3 Calibration of the measurement Set-up

Before starting the actual measurement, the setup shall be calibrated. Figure C.5 shows an example of a set-up that can be used for calibrating the set-up given in figure C.4 using a substitution antenna and a spectrum analyser. It shall be verified that the level of the blocking signal at the input of the substitution antenna corresponds with the levels used for conducted measurements (see clause 5.4.11).

For test sites with a fixed setup of the measurement antenna(s) and a reproducible positioning of the UUT, correction values from a verified site calibration may be used alternatively.

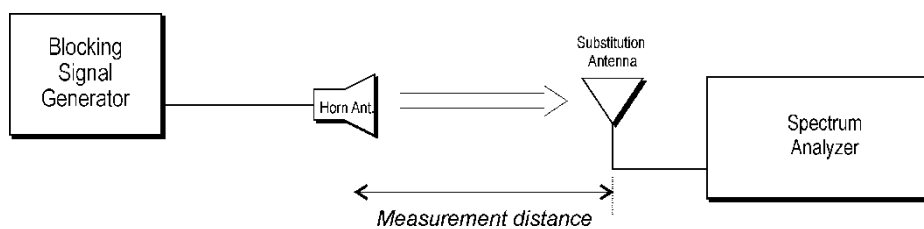

Figure C.5: Measurement Set-up - Calibration

C.5.4.4 Test method

The test procedure shall be as follows:

- Replace the substitution antenna with the UUT once the calibration is performed.
- The UUT shall be positioned for maximum e.i.r.p. towards the horn antenna.

The test method is further as described under clause 5.4.11.2.1.

Annex D (informative): Guidance for testing 2,4 GHz IEEE 802.11™ Equipment

D.1 Introduction

The following guidance may be used by test labs and manufacturers when evaluating compliance of 2,4 GHz IEEE 802.11™ [i.3] radio equipment to the present document. The technology-specific information in this annex *does not* constitute additional requirements and *does not* modify the technical requirements of the present document.

In addition to the mandatory and optional modes defined in the IEEE 802.11™ [i.3] technology standard, Smart Antenna Systems may utilize additional modes of operation not defined in the IEEE 802.11™ [i.3] standard. Therefore, this annex presents a non-exhaustive list of the most commonly expected modes and operating states for IEEE 802.11™ [i.3]-based equipment with the associated references to the appropriate categories for testing in the present document.

The guidance provided in this informative annex assumes that the product utilizes two or more transmit and receive chains.

D.2 Possible Modulations

D.2.1 Introduction

Listed below are the most common modulation types and channel widths used by 2,4 GHz IEEE 802.11™ [i.3] equipment:

- IEEE 802.11™ [i.3] non-HT modulations using a single or multiple transmitters with or without transmit CSD.
- IEEE 802.11™ [i.3] HT20: 20 MHz channels with one to four spatial streams (MCS 0 through MCS 76).
- IEEE 802.11™ [i.3] HT40: 40 MHz channels with one to four spatial streams (MCS 0 through MCS 76).

NOTE: A spatial stream is a stream of bits transmitted over a separate spatial dimension. The number of spatial streams is not necessarily equivalent to the number of transmit chains.

D.2.2 Guidance for Testing

D.2.2.1 Introduction

The objective is to test the equipment in configurations which result in the highest e.i.r.p. and e.i.r.p. density. These configurations are further referred to as the worst-case.

D.2.2.2 Modulation Used for Conformance Testing

One worst case modulation type for 20 MHz operation (and one worst case modulation type for 40 MHz operation, if supported) should be identified and used for conformance testing per the present document.

Where the 20 MHz and 40 MHz modes support different numbers of transmit chains and spatial streams, testing may need to be performed to identify the worst case configuration.

Comparison measurements of RF Output Power and Power Spectral Density, across all modulations can be used to establish the worst case modulation type for 20 MHz operation (and the worst case modulation type for 40 MHz if supported). If 40 MHz operation is supported, two sets of RF Output Power and Power Spectral Density conformance tests should be performed:

- Worst-case 20 MHz modulation (non-HT or HT20).

- Worst-case 40 MHz modulation (HT40).

EXAMPLE: If comparison measurements determine that HT20 MCS 0 (6,5 Mbit/s, one spatial stream) is worst-case, then this mode should be used for conformance testing and not any of the other modulations defined in IEEE 802.11™ [i.3]. One worst-case modulation for HT40 operation should be identified and used for the conformance testing.

However, if the product has different transmit power levels for non-HT vs. HT20 operation, then the worst-case modulation type for each should be identified and used for testing. The RF Output Power and the Power Spectral Density need to be repeated for both non-HT and HT20 operation. If in addition, the equipment supports 40 MHz operation, three sets of Output Power and the Power Spectral Density conformance testing should be performed:

- Worst-case non-HT modulation.
- Worst-case HT20 modulation.
- Worst-case HT40 modulation.

Non-HT operation means any of the modulations defined in clause 16, clause 17 or clause 19 of IEEE 802.11™ [i.3].

In some operating modes, the CSD feature may be disabled. Comparison testing between CSD enabled and CSD disabled determines the worse-case configuration, and this configuration is used during the conformance testing.

D.3 Possible Operating Modes

D.3.1 Introduction

Listed below are the most common operating states of multiple transmit/receive chains within Smart Antenna Systems:

- Beamforming feature implemented and enabled or disabled.
- All available transmit and receive chains enabled.
- A subset of the present transmit/receive chains temporarily disabled during normal operation (i.e. dynamically, based on link conditions or power requirements). In this case, a vendor may implement higher transmit power settings (dynamically) for the active transmit chains.
- Although not commonly expected, it is possible that an equipment may utilize different transmit power settings between one or more of the present transmit chains.

D.3.2 Guidance for Testing

Output Power and the Power Spectral Density tests should be repeated using the worst-case modulations as described in clause D.2.2 and in the following operating states when supported by the equipment:

- Where one or more of the transmit chains is manually or automatically disabled during normal operation and different target RF output power levels are used depending on the number of active transmit chains, then Output Power and the Power Spectral Density conformance testing should be performed using each configuration:

EXAMPLE 1: An equipment with three transmit chains may support an operating mode using three transmit chains at one power level and another operating mode in which one transmit chain is using a higher power level while the other transmit chains are disabled. Output Power and the Power Spectral Density conformance testing should be repeated (using the worst-case modulation types described above) for both of the above mentioned (three-transmit and single-transmit) operating modes.

EXAMPLE 2: For an equipment with three transmit chains, testing does not need to be repeated for all the transmit chains if that equipment does not change its (per transmit chain) RF Output Power based on the number of active chains.

- Where a beamforming feature is implemented, conformance testing should be performed as indicated for an equipment with a beamforming feature:
 - Where the beamforming feature may be disabled manually or automatically, conformance testing does not need to be repeated if the (per transmit chain) RF output power settings remain unchanged.
 - Where the beamforming feature may be disabled manually or automatically, conformance testing needs to be repeated if different (per transmit chain) RF output power settings are used.

Annex E (informative): Application form for testing

E.1 Introduction

Notwithstanding the provisions of the copyright clause related to the text of the present document, ETSI grants that users of the present document may freely reproduce the application form pro forma in this annex so that it can be used for its intended purposes and may further publish the completed application form.

The form contained in this annex may be used by the manufacturer to comply with the requirement contained in clause 5.4.1 to provide the necessary information about the equipment to the test laboratory prior to the testing. It contains product information as well as other information which might be required to define which configurations are to be tested, which tests are to be performed as well the test conditions.

This application form should form an integral part of the test report.

E.2 Information as required by ETSI EN 300 328 V2.1.1, clause 5.4.1

In accordance with ETSI EN 300 328, clause 5.4.1, the following information is provided by the manufacturer.

a) The type of modulation used by the equipment:

- FHSS
- other forms of modulation

b) In case of FHSS modulation:

- In case of non-Adaptive Frequency Hopping equipment:
The number of Hopping Frequencies:
- In case of Adaptive Frequency Hopping Equipment:
The maximum number of Hopping Frequencies:
The minimum number of Hopping Frequencies:
- The (average) Dwell Time:

c) Adaptive / non-adaptive equipment:

- non-adaptive Equipment
- adaptive Equipment without the possibility to switch to a non-adaptive mode
- adaptive Equipment which can also operate in a non-adaptive mode

d) In case of adaptive equipment:

- The maximum Channel Occupancy Time implemented by the equipment: ms
- The equipment has implemented an LBT based DAA mechanism
- In case of equipment using modulation different from FHSS:
 The equipment is Frame Based equipment

- The equipment is Load Based equipment
- The equipment can switch dynamically between Frame Based and Load Based equipment

The CCA time implemented by the equipment: μ s

- The equipment has implemented a non-LBT based DAA mechanism
- The equipment can operate in more than one adaptive mode

e) In case of non-adaptive Equipment:

The maximum RF Output Power (e.i.r.p.): dBm

The maximum (corresponding) Duty Cycle: %

Equipment with dynamic behaviour, that behaviour is described here. (e.g. the different combinations of duty cycle and corresponding power levels to be declared):

.....

.....

.....

f) The worst case operational mode for each of the following tests:

- RF Output Power
.....
- Power Spectral Density
.....
- Duty cycle, Tx-Sequence, Tx-gap
.....
- Accumulated Transmit time, Frequency Occupation & Hopping Sequence (only for FHSS equipment)
.....
- Hopping Frequency Separation (only for FHSS equipment)
.....
- Medium Utilization
.....
- Adaptivity & Receiver Blocking
.....
- Nominal Channel Bandwidth
.....
- Transmitter unwanted emissions in the OOB domain
.....
- Transmitter unwanted emissions in the spurious domain
.....

- Receiver spurious emissions

.....

g) The different transmit operating modes (tick all that apply):

- Operating mode 1: Single Antenna Equipment
- Equipment with only one antenna
 - Equipment with two diversity antennas but only one antenna active at any moment in time
 - Smart Antenna Systems with two or more antennas, but operating in a (legacy) mode where only one antenna is used (e.g. IEEE 802.11™ [i.3] legacy mode in smart antenna systems)
- Operating mode 2: Smart Antenna Systems - Multiple Antennas without beam forming
- Single spatial stream / Standard throughput / (e.g. IEEE 802.11™ [i.3] legacy mode)
 - High Throughput (> 1 spatial stream) using Nominal Channel Bandwidth 1
 - High Throughput (> 1 spatial stream) using Nominal Channel Bandwidth 2

NOTE 1: Add more lines if more channel bandwidths are supported.

- Operating mode 3: Smart Antenna Systems - Multiple Antennas with beam forming
- Single spatial stream / Standard throughput (e.g. IEEE 802.11™ [i.3] legacy mode)
 - High Throughput (> 1 spatial stream) using Nominal Channel Bandwidth 1
 - High Throughput (> 1 spatial stream) using Nominal Channel Bandwidth 2

NOTE 2: Add more lines if more channel bandwidths are supported.

h) In case of Smart Antenna Systems:

- The number of Receive chains:
- The number of Transmit chains:
 - symmetrical power distribution
 - asymmetrical power distribution

In case of beam forming, the maximum (additional) beam forming gain: dB

NOTE: The additional beam forming gain does not include the basic gain of a single antenna.

i) Operating Frequency Range(s) of the equipment:

- Operating Frequency Range 1: MHz to MHz
- Operating Frequency Range 2: MHz to MHz

NOTE: Add more lines if more Frequency Ranges are supported.

j) Nominal Channel Bandwidth(s):

- Nominal Channel Bandwidth 1: MHz
- Nominal Channel Bandwidth 2: MHz

NOTE: Add more lines if more channel bandwidths are supported.

k) Type of Equipment (stand-alone, combined, plug-in radio device, etc.):

- Stand-alone
- Combined Equipment (Equipment where the radio part is fully integrated within another type of equipment)
- Plug-in radio device (Equipment intended for a variety of host systems)
- Other

l) The normal and the extreme operating conditions that apply to the equipment:**Normal operating conditions (if applicable):**

Operating temperature: ° C

Other (please specify if applicable):

Extreme operating conditions:

Operating temperature range: Minimum: ° C Maximum ° C

Other (please specify if applicable): Minimum: Maximum

- Details provided are for the: stand-alone equipment
- combined (or host) equipment
- test jig

m) The intended combination(s) of the radio equipment power settings and one or more antenna assemblies and their corresponding e.i.r.p. levels:

• Antenna Type:

- Integral Antenna (information to be provided in case of conducted measurements)

Antenna Gain: dBi

If applicable, additional beamforming gain (excluding basic antenna gain): dB

- Temporary RF connector provided
- No temporary RF connector provided

- Dedicated Antennas (equipment with antenna connector)
- Single power level with corresponding antenna(s)
- Multiple power settings and corresponding antenna(s)

Number of different Power Levels:

Power Level 1: dBm

Power Level 2: dBm

Power Level 3: dBm

NOTE 1: Add more lines in case the equipment has more power levels.

NOTE 2: These power levels are conducted power levels (at antenna connector).

- For each of the Power Levels, provide the intended antenna assemblies, their corresponding gains (G) and the resulting e.i.r.p. levels also taking into account the beamforming gain (Y) if applicable

Power Level 1: dBm

Number of antenna assemblies provided for this power level:

Assembly #	Gain (dBi)	e.i.r.p. (dBm)	Part number or model name
1			
2			
3			
4			

NOTE 3: Add more rows in case more antenna assemblies are supported for this power level.

Power Level 2: dBm

Number of antenna assemblies provided for this power level:

Assembly #	Gain (dBi)	e.i.r.p. (dBm)	Part number or model name
1			
2			
3			
4			

NOTE 4: Add more rows in case more antenna assemblies are supported for this power level.

Power Level 3: dBm

Number of antenna assemblies provided for this power level:

Assembly #	Gain (dBi)	e.i.r.p. (dBm)	Part number or model name
1			
2			
3			
4			

NOTE 5: Add more rows in case more antenna assemblies are supported for this power level.

n) The nominal voltages of the stand-alone radio equipment or the nominal voltages of the combined (host) equipment or test jig in case of plug-in devices:

Details provided are for the: stand-alone equipment
 combined (or host) equipment
 test jig

Supply Voltage AC mains State AC voltage V
 DC State DC voltage V

In case of DC, indicate the type of power source

- Internal Power Supply
 External Power Supply or AC/DC adapter
 Battery
 Other:

o) Describe the test modes available which can facilitate testing:

.....

p) The equipment type (e.g. Bluetooth[®], IEEE 802.11[™] [i.3], IEEE 802.15.4[™] [i.4], proprietary, etc.):

.....

q) If applicable, the statistical analysis referred to in clause 5.4.1 q)

(to be provided as separate attachment)

r) If applicable, the statistical analysis referred to in clause 5.4.1 r)

(to be provided as separate attachment)

s) Geo-location capability supported by the equipment:

Yes

The geographical location determined by the equipment as defined in clause 4.3.1.13.2 or clause 4.3.2.12.2 is not accessible to the user

No

t) Describe the minimum performance criteria that apply to the equipment (see clause 4.3.1.12.3 or clause 4.3.2.11.3):

.....

E.3 Configuration for testing (see clause 5.3.2.3 of ETSI EN 300 328 V2.1.1)

From all combinations of conducted power settings and intended antenna assembly(ies) specified in clause 5.4.1 m), specify the combination resulting in the highest e.i.r.p. for the radio equipment.

Unless otherwise specified in ETSI EN 300 328, this power setting is to be used for testing against the requirements of ETSI EN 300 328. In case there is more than one such conducted power setting resulting in the same (highest) e.i.r.p. level, the highest power setting is to be used for testing. See also ETSI EN 300 328, clause 5.3.2.3.

Highest overall e.i.r.p. value:	dBm	
Corresponding Antenna assembly gain:	dBi	Antenna Assembly #:
Corresponding conducted power setting: (also the power level to be used for testing)	dBm	Listed as Power Setting #:

E.4 Additional information provided by the manufacturer

E.4.1 Modulation

ITU Class(es) of emission:

Can the transmitter operate unmodulated? yes no

E.4.2 Duty Cycle

- The transmitter is intended for:
- Continuous duty
 - Intermittent duty
 - Continuous operation possible for testing purposes

E.4.3 About the UUT

- The equipment submitted are representative production models
- If not, the equipment submitted are pre-production models?
- If pre-production equipment are submitted, the final production equipment will be identical in all respects with the equipment tested
- If not, supply full details
 -
 -

E.4.4 Additional items and/or supporting equipment provided

- Spare batteries (e.g. for portable equipment)
- Battery charging device
- External Power Supply or AC/DC adapter
- Test jig or interface box
- RF test fixture (for equipment with integrated antennas)
- Host System
 - Manufacturer:
 - Model #:
 - Model name:
- Combined equipment
 - Manufacturer:
 - Model #:
 - Model name:
- User Manual
- Technical documentation (Handbook and circuit diagrams)

Annex F (informative): Change History

Version	Information about changes
2.1.1	First published version covering Directive 2014/53/EU [i.1]. Major changes are: <ul style="list-style-type: none">• Inclusion of Receiver Blocking as a new requirement.• Inclusion of an alternative test method for Power Spectral Density.• Modifications required for alignment with the Directive 2014/53/EU [i.1].• Reduction of minimum number for hopping frequencies for non-adaptive FHSS equipment.

History

Document history		
Edition 1	November 1994	Publication as ETSI ETS 300 328
Edition 2	November 1996	Publication as ETSI ETS 300 328
Amendment 1	July 1997	Amendment 1 to 2 nd Edition of ETSI ETS 300 328
V1.2.2/V1.1.1	July 2000	Publication as ETSI EN 300 328 part 1 and part 2
V1.3.1/ V1.2.1	December 2001	Publication as ETSI EN 300 328 part 1 and part 2
V1.4.1	April 2003	Publication
V1.5.1	August 2004	Publication
V1.6.1	November 2004	Publication
V1.7.1	October 2006	Publication
V1.8.1	June 2012	Publication
V1.9.1	February 2015	Publication
V2.0.20	March 2016	EN Approval Procedure AP 20160605: 2016-03-07 to 2016-06-06
V2.1.0	September 2016	Vote V 20161113: 2016-09-14 to 2016-11-14
V2.1.1	November 2016	Publication